

INTERIORS

Furniture, Accessories & Functional design

Caimi

**vicini alle persone
vicini al futuro**

**close to people
close to the future**

Interiors

Furniture, Accessories & Functional design

**Versatile seating
p. 16**



Clicca e vai alla pagina selezionata.

Click and go to the selected page.



STILEMI
p. 18



SHOPPER
p. 24

**Dividers
p. 32**



Clicca e vai alla pagina selezionata.

Click and go to the selected page.



CLIP
p. 34



ARIANNA
p. 46

**Recycling
p. 50**



Clicca e vai alla pagina selezionata.

Click and go to the selected page.



LINEAR
p. 52



BINZ
p. 56



MAXI
p. 58



MAXIMO
p. 60



MAXIMO Lock
p. 61



MAXIMO Modular
p. 62



CENTOLITRI
p. 64



CENTOLITRI Lock
p. 68



PRISMA
p. 70

**Shelving systems & Bibliotech
p. 214**



Clicca e vai alla pagina selezionata.

Click and go to the selected page.



BIG
p. 216



SOCRATE
p. 228



SOCRATE Outdoor
p. 258



BIBLIOTECH
p. 270

**Lighting
p. 150**



Clicca e vai alla pagina selezionata.

Click and go to the selected page.



TELETA
p. 152



OPERA
p. 156

**Tables & Seating
p. 160**



Clicca e vai alla pagina selezionata.

Click and go to the selected page.



PEGASO Glass
p. 162



PEGASO Infinito
p. 166



PEGASO Metal
p. 170



PEGASO Cemento
p. 170



PEGASO Wood
p. 180



PEGASO Solid
p. 180



SUSU
p. 190



JOLLY
p. 192



CICERONE
p. 196



KALEIDOS
p. 200



KALEIDOS Beam
p. 208



ULISSE
p. 210

**Accessories
p. 78**

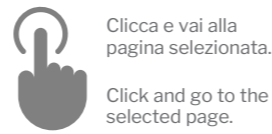

LUTHEA
p. 80



STELLA
p. 84



MET'ALL
p. 86



SWING
p. 90



QUADRANGOLO
p. 92



GIOIA
p. 94



ELK
p. 96



EVA
p. 98



KING
p. 99



MAESTRALE
p. 100



BATTISTA Color
p. 102



BATTISTA
p. 106



BATTISTA Hook
p. 110



HOOK
p. 111



DUO
p. 112

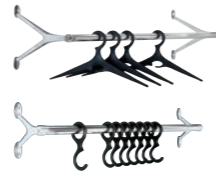

AMBROGIO
AMBROGINO
p. 114



OMETTO
HANGER
p. 116



RAPID
p. 118



SPEECH Stander
p. 119



SWING
p. 120



HI-TECH
p. 122



DIVIDO
p. 124



DESIGN COLLECTION
p. 126



HI-TECH
p. 130

**Accessories
p. 78**

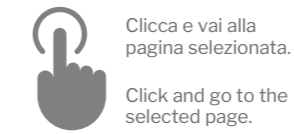

PIOGGIA
p. 132



SET
p. 133



ESTERNO
p. 134



PIAZZA
p. 136



SMILE
p. 137

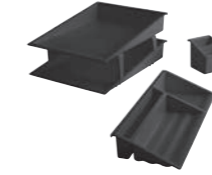

DESK-UP
p. 138



BISS
p. 140



UP
p. 141



HI-TECH
p. 141



OREDODICI
p. 142



ST DORFLES
p. 144



PLAT / KABO
p. 146-148

**Communication & Meeting
p. 282**

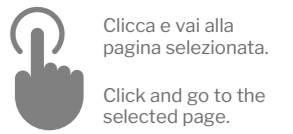

MEETING
p. 284



SPEECH
p. 290

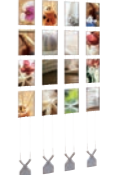

KOALA
p. 298



KOALA Totem
p. 304



BATTISTA Stanchion
p. 306



SET
p. 310



GASTONE
p. 316

CAIMI BREVETTI

Made in Italy since 1949

I_Fondata nel 1949, Caimi è una delle principali realtà produttive europee design oriented nel settore dell'arredamento, dei complementi d'arredo e delle soluzioni acustiche per l'ufficio, la casa e il contract. Da **75 anni** Caimi continua a ricercare e sperimentare nuove soluzioni per migliorare concretamente la vita delle persone e gli ambienti in cui vivono. Grazie ad una sofisticata integrazione fra struttura produttiva e logistica, gestisce con successo una gamma di prodotti composta da oltre **3.500** articoli e **35.000** componenti, garantendo alla propria clientela tempi di consegna estremamente rapidi.

EN_Founded in 1949, Caimi is one of the leading European design-oriented manufacturers of furniture and complements for the office, home and contract sectors. For **75 years** Caimi has continued to research and assay new solutions for the betterment of people's lives and living spaces. Thanks to its sophisticated integration of production line work and logistics operations, Caimi can effect extremely fast deliveries of any orders from its product range, which is made up of around **3.500** items and more than **35.000** separate components.

F_Fondée en 1949, Caimi est l'une des principales entreprises européennes de production axée sur le design, dans le domaine de l'ameublement, des accessoires de décoration et des solutions acoustiques pour le bureau, la maison et les grands projets clé en main. Depuis **75 années**, Caimi est à la recherche de nouvelles solutions pour améliorer de manière concrète la vie des personnes et de leur habitat. Grâce à une intégration sophistiquée entre sa structure de production et la logistique, Caimi peut gérer avec succès une gamme d'environ **3.500** produits avec plus de **35.000** composants, assurant ainsi des délais de livraison extrêmement rapides à ses clients.

D_1949 gegründet, ist Caimi eines der führenden Design-orientierten Hersteller in Europa in der Branche Einrichtung, Einrichtungszubehör und Schalldämpfösungen für Büro, Wohnen und Contract. Seit **75 Jahren** erforscht und experimentiert Caimi neue Lösungen, um das Leben der Menschen und die Räume, in denen sie leben, zu verbessern. Dank der hochentwickelten Integration zwischen Produktion und Logistik kann Caimi eine breite Palette an Produkten erfolgreich herstellen und vertreiben, die über **3.500** Produkte und **35.000** Komponenten miteinschließt, und somit den eigenen Kunden extrem schnelle Lieferzeiten garantieren.

E_Fundada en 1949, Caimi es una de las principales empresas productoras europeas dedicada al diseño en el sector del interiorismo, de los complementos decorativos y de las soluciones acústicas para oficina, hogar y contract. Desde hace **75 años**, Caimi investiga y desarrolla, de forma continua, novedosas soluciones para mejorar el bienestar de las personas y el entorno en el que viven. Gracias a una integración avanzada entre estructura de producción y logística, gestiona exitosamente una gama de productos que consta de más de **3.500** artículos y **35.000** componentes, garantizando a sus clientes plazos de entrega sumamente rápidos.



Download
Company
profile



Clicca e scarica
il pdf.
Click and download
pdf file.

AWARDS

Over **70** international awards

I_Le molteplici iniziative di Caimi nel design, nella ricerca e nella cultura hanno portato all'esposizione dei suoi prodotti presso mostre e musei e l'hanno vista protagonista di prestigiosi eventi e di importanti premi e riconoscimenti, tra i quali tre Premi Compasso d'Oro ADI, tre Menzione d'Onore al Compasso d'Oro ADI, il premio DesignEuropa Awards (assegnato dall'Ufficio dell'Unione Europea per la proprietà intellettuale, EUIPO), numerose selezioni ADI Design Index e tre German Design Award. Nel 2020 quattro prodotti Caimi sono entrati a far parte della collezione permanente di Arte e Design del Quirinale (Residenza del Presidente della Repubblica Italiana).

EN_Caimi's many initiatives in design, research and culture have led to the display of its products at exhibitions and museums while playing a leading role in prestigious events and receiving important prizes and awards, including three ADI Compasso d'Oro Awards, three ADI Compasso d'Oro Honourable Mentions, the DesignEuropa Awards (assigned by the European Union Intellectual Property Office, EUIPO), numerous ADI Design Index selections and three German Design Awards. In 2020, four Caimi products became part of the permanent collection of Art and Design at the Quirinale (Residence of the President of the Italian Republic).

F_Les nombreuses initiatives de Caimi dans le design, dans la recherche et dans la culture, ont permis d'exposer ses produits dans des expositions et des musées, et ont fait de Caimi une vedette prestigieuses lors d'événements, de prix et reconnaissances importants, dont trois Prix Compas d'Or ADI, trois Mentions d'honneur au Compas d'Or ADI, le prix DesignEuropa Awards (délivré par l'Office de l'Union européenne pour la propriété intellectuelle, EUIPO), de nombreuses sélections ADI Design Index et trois prix German Design Award. En 2020 quatre produits Caimi sont devenus partie intégrante de la collection permanente d'Art et Design du Quirinale (la résidence du Président de la République italienne).

D_Dank der verschiedenen Initiativen von Caimi in den Bereichen Design, Forschung und Kultur sind die Produkte des Unternehmens auf zahlreichen Ausstellungen und in Museen zu besichtigen. Caimi ist außerdem häufig bei renommierten Veranstaltungen zu Gast und hat wichtige Preise und Auszeichnungen erhalten, darunter drei Compasso d'Oro ADI, drei lobende Erwähnungen zum Compasso d'Oro ADI, den ersten Platz bei den DesignEuropa Awards (vergeben vom Amt der Europäischen Union für geistiges Eigentum, EUIPO), zahlreiche Aufnahmen in den ADI Design Index und drei Designpreise der Bundesrepublik Deutschland. Im Jahr 2020 wurden vier Caimi-Produkte in die ständige Sammlung für Kunst und Design im Quirinalspalast (Amtssitz des italienischen Staatspräsidenten) aufgenommen.

E_Las numerosas iniciativas de Caimi en el ámbito del diseño, la investigación y la cultura han propiciado la exhibición de sus productos en exposiciones y museos y la han convertido en protagonista de prestigiosos eventos y en destinataria de importantes premios y reconocimientos, como tres Premios ADI Compasso d'Oro, tres Menciones de Honor ADI Compasso d'Oro, los Premios DesignEuropa (asignados por la Oficina de Propiedad Intelectual de la Unión Europea, EUIPO), numerosas selecciones ADI Design Index y tres German Design Awards. En 2020, cuatro productos Caimi pasaron a formar parte de la colección permanente de Arte y Diseño del Palacio del Quirinale (Residencia del Presidente de la República Italiana).



I DESIGNERS SONO I NOSTRI OCCHI SUL MONDO

Designers are our eyes on the world

I protagonisti del design industriale sono due: il progettista e l'azienda. Nel caso della Caimi il ruolo dei designer, nel rispetto dell'autonomia inventiva, è direttamente collegato con la costante innovazione tecnologica e di processo che sta dietro ogni prodotto. Da questa filosofia progettuale, discende un metodo particolare: il sapere e le soluzioni originali si costruiscono insieme, passo dopo passo, con accelerazioni, ripensamenti, intuizioni e nuovi paradigmi. Solo così è possibile costruire una relazione virtuosa e continua con ogni singolo designer, nel rispetto del ruolo di ciascuno. Lo stesso sistema di prodotti dell'azienda mette in evidenza l'identità e la riconoscibilità generale del marchio, da un lato, e dall'altro la singolarità di ciascuno dei progettisti coinvolti.

EN There are two central figures in the world of industrial design: the designer and the company. In the case of Caimi the role of the designers, with due respect of their inventive autonomy, is directly linked to the constant innovation of technology and process that lies behind every product. Out of this design philosophy comes a specific method: knowledge and original solutions are built together, step by step, with accelerations, afterthoughts, intuitions and new paradigms. Only in this way it is possible to construct a virtuous, ongoing relationship with each individual designer, respecting the role that each person has to play. The same system of company's products highlights, on the one side, the identity and general recognition of the brand, and on the other, the singularity of each of the designers involved.

F Les protagonistes du design industriel sont au nombre de deux: le concepteur et l'entreprise. Dans le cas de Caimi le rôle des concepteurs, tout en respectant leur autonomie inventive, est directement lié à l'innovation technologique et de processus constante, qui est à la base de chaque produit. Mais cette philosophie conceptuelle donne lieu à une méthode particulière: le savoir et les solutions originales se construisent ensemble, pas après pas, avec des accélérations, des remises en question, l'intuition et les nouveaux paradigmes. Ce n'est que de cette manière qu'il est possible de construire une relation vertueuse et continue avec chaque concepteur, en respectant le rôle de chacun. Le système des produits de l'entreprise met en évidence l'identité et la reconnaissance générale de la marque, d'une part, et le trait distinctif de chaque concepteur, d'autre part.

D Im Industriedesign gibt es zwei Hauptakteure: Der Designer und das Unternehmen. Im Fall von Caimi verbindet sich die Rolle der Designer und die Achtung vor deren erfinderischer Freiheit mit der fortlaufenden Innovation von Technologien und Verfahren, die hinter jedem Produkt steht. Aus dieser Entwurfsphilosophie ergibt sich eine besondere Methode: das Wissen und die originellen Lösungen werden zusammen erarbeitet in einem schrittweisen Prozess, das Beschleunigungen wie Umdenken, Intuitionen und neue Paradigmen mit einschließt. Nur so kann man ein produktives und kontinuierliches Verhältnis zu jedem einzelnen Designer aufbauen, in dem die Rolle eines jeden geachtet wird. Selbst bei unserem Produktsystem stehen sowohl die Identität und allgemeine Erkennbarkeit der Marke als auch das individuelle Profil eines jeden der mitarbeitenden Designer gleichberechtigt im Vordergrund.

E El diseño industrial tiene dos protagonistas: el diseñador y la empresa. Para Caimi el papel del diseñador, siempre respetando su independencia creadora, está directamente vinculado a la constante innovación tecnológica y del proceso subyacentes a todo producto. De esta filosofía del diseño se desprende un método particular: el conocimiento y las soluciones originales se construyen juntos, paso a paso, con aceleraciones, replanteamientos, intuiciones y nuevos paradigmas. Tan sólo así se logra entablar una relación virtuosa y continua con cada diseñador, respetando el papel de cada uno. Hasta en el mismo sistema de productos de la empresa destaca la identidad y el reconocimiento general de la marca por una parte, y la individualidad de cada uno de los diseñadores involucrados por la otra.

Acropoli

Sezgin Aksu

Alessandro Angelotti

Archistudio

Pietro Arosio

Stefano Barzaghi

Claudio Bellini

Mario Bellini

Chiara Bevegni

Claus Breinholt

Caimi Lab

Letterio Cardile

Aldo Cibic

Marco Cocco

Massimo Colagrande

Paul De Feiter

Michele De Lucchi

Gillo Dorfles

Frida Doveil

Giancarlo Fassina

Moreno Ferrari

Carlo Forcolini

Graziano Friscione

Ton Haas

Hsiang Han Hsu

Giulio Iacchetti

Id Vision

M+A+P Design Studio

Raffaello Manzoni

Alessandro Mendini

Atelier Mendini

Gianni Menguzzato

Claudio Nascimben

Philippe Nigro

Eleonore Peduzzi Riva

Pierandrei Associati

Francesco Radaelli

Matteo Ragni

Marc Sadler

Francesca Smiraglia

Lorenzo Stano

SI Design

Silvia Suardi

Mario Trimarchi

Alessandro Zambelli

SUSTAINABILITY

Environmentally conscious design

I_Caimi, da sempre sensibile nei confronti delle tematiche ambientali e dell'ecosostenibilità, utilizza, dove tecnicamente possibile, materiali riciclati, riciclabili o riutilizzabili. La produzione è composta in prevalenza da oggetti monomaterici, che garantiscono una facile riciclabilità mentre gli oggetti composti da più materiali sono disassemblabili, consentendo di riciclare separatamente le singole parti. I sistemi modulari Caimi sono inoltre riconfigurabili e i singoli componenti sostituibili al fine di adeguarsi alle mutate esigenze degli ambienti in cui sono inseriti.

EN_Caimi, which has always been sensitive to environmental issues and eco-sustainability, uses recycled, recyclable or reusable materials wherever technically possible. Production is mainly composed of single-material objects, which guarantee easy recyclability, while objects composed of several materials can be disassembled, allowing the individual parts to be recycled separately. Caimi's modular systems are also reconfigurable and individual components can be replaced in order to adapt to the changing needs of the environments they are placed in.

F_Depuis toujours Caimi a été sensible aux thèmes de l'environnement et du développement durable, en utilisant des matériaux recyclés, recyclables ou réutilisables, lorsque c'est techniquement possible. La production est principalement composée d'objets monomatériaux, qui garantissent une recyclabilité aisée, tandis que les objets composés de plusieurs matériaux peuvent être désassemblés, ce qui permet de recycler les différentes parties séparément. Les systèmes modulaires Caimi peuvent également être reconfigurés et les différents composants remplaçables peuvent s'adapter à l'évolution des exigences des habitats où il sont utilisés.

D_Caimi ist seit jeher mit Umweltthemen und der Umweltverträglichkeit vertraut und verwendet, wo technisch möglich, wiederverwertbare oder recyclebare Materialien. Die Produktion besteht überwiegend aus Monomaterial- Gegenständen, die leicht recyclebar sind: die Gegenstände aus mehreren Materialien sind zum Großteil so entwickelt, dass sie auseinander gebaut werden können, wodurch das Recycling der einzelnen Komponenten ermöglicht wird. Die Produkte Snowsound Technology, die Snowsound Fiber Stoffe und Snowall sind mit der Greenguard Gold-Zertifizierung ausgezeichnet worden, die die Anwendung von Materialien mit geringen chemischen Emissionen und deren Beitrag zur verbesserten Raumqualität bezeugt.

E_Caimi, que siempre ha sido sensible a las cuestiones medioambientales y de ecosostenibilidad, utiliza materiales reciclados, reciclables o reutilizables siempre que resulta técnicamente posible. La producción se compone principalmente de objetos elaborados en un material único, lo que garantiza una fácil reciclabilidad, mientras que los objetos compuestos de varios materiales son desensamblables, lo que permite reciclar cada una de sus partes por separado. Además, los sistemas modulares de Caimi son reconfigurables y sus componentes individuales pueden sustituirse para adaptarse a los eventuales cambios en las necesidades de los entornos en los que se integran.



**Guarda
il video**



**Watch
the video**



Clicca e guarda
il video.

Click and watch
the video.



IL BREVETTO COME TUTELA DELL'ORIGINALITÀ

The patent as protection of originality

I_Fin dalla sua fondazione nel 1949, Caimi Brevetti ha posto al centro della sua missione la tutela dell'invenzione, tanto da inserire "Brevetti" all'interno della sua ragione sociale. La pratica di brevettare va oltre la semplice registrazione di idee; essa incarna l'essenza stessa della progettazione, ponendo la ricerca e la conoscenza al vertice di ogni attività industriale. Questo approccio riveste un valore strategico perché pone al centro dei progetti la volontà di trovare soluzioni reali ai bisogni delle persone. I **1168 Brevetti e modelli depositati o acquisiti dall'azienda** sono la conferma del valore che Caimi pone alla tutela della proprietà intellettuale.

EN_Ever since its foundation in 1949, Caimi Brevetti has placed the protection of invention at the center of its mission, so much so that it has included 'Patents' within its company name. The practice of patenting goes beyond the mere registration of ideas; it embodies the very essence of design, placing research and knowledge at the top of every industrial activity. This approach is of strategic value because it places the desire to find real solutions to people's needs at the center of projects. The **1168 patents and registered models** confirm the importance Caimi places on the protection of intellectual property.

F_Depuis sa création en 1949, Caimi Brevetti a placé la protection des inventions au centre de sa mission, à tel point que le terme « Brevetti » (brevets) figure dans sa raison sociale. Déposer un brevet va au-delà d'un simple enregistrement des idées ; il s'agit de l'essence même de la conception, où la recherche et le savoir se trouvent au premier plan de toute activité industrielle. Cette approche possède une valeur stratégique, car elle place au centre des projets, la volonté de trouver des solutions réelles pour les exigences des personnes. Les **1168 brevets et modèles déposés ou achetés par l'entreprise**, confirment l'importance que Caimi accorde à la protection de la propriété intellectuelle.

D_Seit seiner Gründung im Jahr 1949 hat Caimi Brevetti den Schutz von Erfindungen in den Mittelpunkt seines Auftrags gestellt, sogar so sehr, dass der Begriff „Patente“ (italienisch Brevetti) in den Firmennamen aufgenommen wurde. Die Praxis der Patentierung geht über die bloße Registrierung von Ideen hinaus; sie verkörpert das eigentliche Wesen des Designs und stellt Forschung und Wissen an die Spitze jeder industriellen Tätigkeit. Dieser Ansatz ist von strategischem Wert, denn er stellt den Wunsch, echte Lösungen für die Bedürfnisse der Menschen zu finden, in den Mittelpunkt der Projekte. Die **1168 Patente und Muster, die das Unternehmen angemeldet oder erworben hat**, bestätigen die Bedeutung, die Caimi dem Schutz des geistigen Eigentums beimisst.

E_Desde su fundación en 1949, Caimi Brevetti ha situado la protección de la invención en el centro de su misión, hasta el punto de incluir "Brevetti" (patentes) en el nombre de la empresa. Patentar va más allá de un mero registro de ideas; encarna la propia esencia del diseño, poniendo la investigación y el conocimiento en la cumbre de cualquier actividad industrial. Este enfoque reviste un valor estratégico, ya que sitúa el deseo de encontrar soluciones reales para satisfacer las necesidades de las personas en el centro de los proyectos. Las **1168 patentes y modelos registrados o adquiridos por la empresa** confirman la importancia que Caimi concede a la protección de la propiedad intelectual.

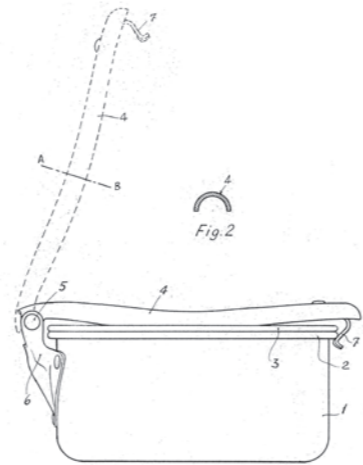

La 2000 "Schiscetta" - patented 1952

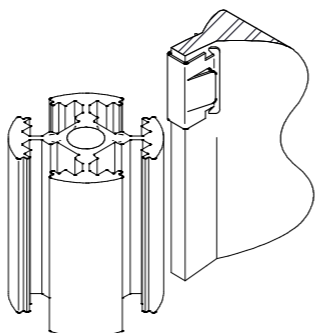

Clip - patented 2024

MADE IN ITALY

I_Caimi associa alla precisione del processo industriale la cura dei dettagli e delle finiture tipica della migliore produzione artigianale italiana. Una metodologia di lavoro che unisce la qualità del saper fare artigianale alla tecnologia di un'azienda moderna, avanzata, fortemente legata al territorio e capace di valorizzare prodotti **100% made in Italy**.

EN_Caimi combines the precision of the industrial process with the attention to detail and typical of the best Italian craftsmanship. A working methodology that combines the quality of craftsmanship with the technology of a modern, advanced company, strongly linked to the territory and capable of enhancing products **100% made in Italy**.

F_Caimi associe à la précision du processus industriel, le soin du détail et des finitions typiques de la meilleure production artisanale italienne. Une méthodologie de travail qui allie la qualité de l'artisanat à la technologie d'une entreprise moderne et avancée, fortement liée au territoire et capable de valoriser les produits **100% Made in Italy**.

D_Caimi verbindet die Präzision des industriellen Prozesses mit der Liebe zum Detail und der Verarbeitung, die für feinste italienische Handwerkskunst typisch sind. Eine Arbeitsmethode, die die Qualität des Handwerks mit der Technologie eines modernen, fortschrittlichen Unternehmens verbindet, das eng mit seiner Heimat verbunden ist und zu **100 % in Italien** hergestellte Produkte realisiert.

E_Caimi concilia la precisión del proceso industrial con la atención al detalle y los acabados característicos de la mejor artesanía italiana. Un método de trabajo que fusiona la calidad de la artesanía con la tecnología de una empresa moderna y avanzada, fuertemente vinculada al territorio y capaz de aportar valor con productos **100% made in Italy**.

OPEN LAB

Research, Academy & No Profit



I_Open Lab è uno spazio all'avanguardia che vanta 7 laboratori avveniristici dedicati alla ricerca teorica e applicata in ambito tecnologico, acustico e fisico. Un centro di ricerca volto a sperimentare il comportamento del suono, le capacità percettive dell'uomo e gli effetti che il suono ha sull'essere umano. In linea con le tradizioni della nostra azienda da sempre sensibile ai problemi sociali e con l'obiettivo di trovare soluzioni che contribuiscano a rendere migliore la qualità della vita, Open Lab è anche una struttura no profit gratuitamente messa al servizio di Università, Istituti di Ricerca, Fondazioni ed Enti. Open Lab, un grande laboratorio aperto al mondo, perché non esiste innovazione senza ricerca.

EN_Open Lab is an advanced facility housing 7 futuristic laboratories dedicated to theoretical and applied research in technology, acoustics and physics. The purpose of the research facility is to carry out experiments on the behaviour of sound, on the perceptive capacities of humans, and on the effects of sound on people. In keeping with the traditions of our company, which has always been socially aware and has always aspired to solutions that improve the quality of life of all, Open Lab operates as a not-for-profit entity that is placed free of charge at the disposition of universities, research institutes, foundations and public-sector bodies. Open Lab: A laboratory complex whose doors are open to the world; without research, there can be no innovation.

F_Open Lab est un lieu à l'avant-garde qui vante 7 laboratoires ultra-modernes dédiés à la recherche théorique et appliquée dans le domaine technologique, acoustique et physique. Un centre de recherche pour expérimenter le comportement du son, la capacité perceptive et les effets du son sur les êtres humains. En ligne avec les traditions de notre entreprise, depuis toujours sensible aux problèmes sociaux et à la recherche de solutions qui contribueront à améliorer la qualité de vie, Open Lab est en même temps une structure sans but lucratif au service des universités, instituts de recherche, fondations et autres organismes. Open Lab, un grand laboratoire ouvert au monde, car l'innovation ne peut exister sans la recherche.

D_Open Lab ist ein Experimentierraum mit 7 zukunftsweisenden Labors, die sich mit theoretischer Forschung und ihrer Anwendung auf Technologie, Akustik und Physik befassen. Ziel des Forschungszentrums ist die Auslotung von Schallverhalten und menschlicher Wahrnehmung sowie der Auswirkungen von Schall auf den Menschen. Im Einklang mit der Tradition eines Unternehmens, das schon immer empfänglich war für soziale Themen und mit dem Ziel, Lösungen zu entwickeln, die zur Besserung der Lebensqualität beitragen, gestaltet sich Open Lab gleichzeitig als gemeinnützige Struktur, die kostenlos im Dienst von Universitäten, Forschungsinstituten, Stiftungen und Einrichtungen arbeitet. Open Lab ist ein großes, der Welt offenes Labor, weil es ohne Forschung keine Innovation gibt.

E_Open Lab es un espacio vanguardista que cuenta con 7 laboratorios punteros orientados a la investigación teórica y aplicada en el ámbito tecnológico, acústico y físico. Un centro de investigación que permite experimentar el comportamiento del sonido, la capacidad de percepción del ser humano y los efectos que el sonido ejerce sobre este. De acuerdo con la tradición de nuestra empresa, siempre atenta a los problemas sociales y con el objetivo de encontrar soluciones que logren aportar mejoras a la calidad de vida, Open Lab es también una estructura sin ánimo de lucro que se pone al servicio de Universidades, Institutos de Investigación, Fundaciones y Entidades. Open Lab es también una estructura sin ánimo de lucro que se pone al servicio de Universidades, Institutos de Investigación, Fundaciones y Entidades. Open Lab es un gran laboratorio abierto al mundo, pues no existe innovación sin investigación.



Guarda
il video



Watch
the video



Clicca e guarda
il video.

Click and watch
the video.

SUPERNOVA LAB, semi-anechoic chamber

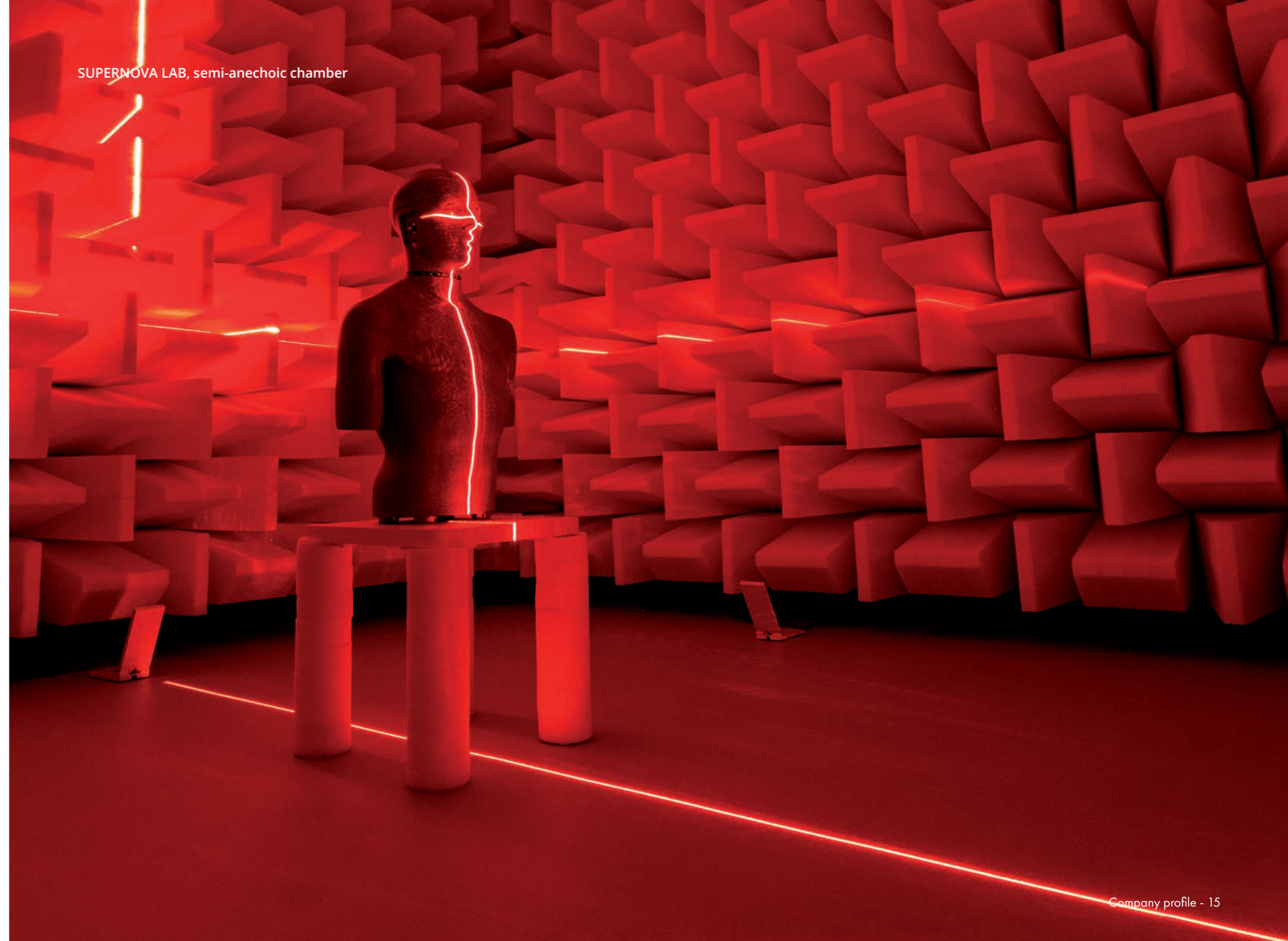

Versatile seating

I Collezioni di sedute giocose e versatili che uniscono comfort e creatività. Ogni pezzo invita ad arredare lo spazio con uno stile elegante, ma informale, consentendo di riadattare con semplicità l'ambiente in base alle mutevoli esigenze quotidiane. La libertà di trasformare ogni seduta in un'esperienza unica.

EN Our playful and versatile seating collections combine comfort with creativity. Each piece invites one to add a touch of elegance and informality to a space, and can effortlessly adapt and re-adapt to daily needs. Enjoy the freedom to create a unique seating experience every time.

F Des collections de sièges ludiques et polyvalents qui allient confort et créativité. Chaque élément vous invite à meubler l'espace avec un style à la fois élégant et informel, vous permettant de réajuster facilement vos espaces en fonction de l'évolution de vos besoins quotidiens. La liberté de transformer chaque siège en une expérience unique.

D Verspielte und vielseitige Sitzmöbelkollektionen, die Komfort und Kreativität in Einklang bringen. Jedes Stück lädt dazu ein, den Raum in elegantem und doch ungezwungenem Stil einzurichten, und ihn an die verschiedenen Bedürfnisse im Alltag anzupassen. Genießen Sie sich die Freiheit für ein einzigartiges Sitzenerlebnis.

E Colección de asientos divertidos y versátiles que conjugan confort y creatividad. Cada pieza aporta un toque de estilo elegante pero informal, que permite transformar el ambiente de manera sencilla adaptándose a las variables necesidades cotidianas. La libertad de convertir cada asiento en una experiencia única.

STILEMI

Alessandro Mendini

I Questa collezione traspone alcuni segni tipici del linguaggio stilistico di Alessandro Mendini che diventano oggetti tridimensionali, sfruttabili come sedute, tavolini o semplici elementi di appoggio. Oggetti di natura ibrida che possono colorare un ambiente con un'estrema versatilità di utilizzo.

EN This collection translates key aspects of Alessandro Mendini's signature style into versatile three-dimensional objects. These pieces have an inherently hybrid essence, so they can be used as seats, small tables or simple support elements, adding vibrant versatility to any environment.

F La collection Stilemi transpose quelques-uns des signes typiques du langage stylistique d'Alessandro Mendini qui deviennent des objets tridimensionnels pouvant être utilisés comme sièges, tables ou simples éléments de support. Des objets de nature hybride qui peuvent colorer un espace avec une extrême versatilité d'utilisation.

D Mit dieser Kollektion werden einige typische Symbole der stilistischen Sprache von Alessandro Mendini in dreidimensionale Objekte umgewandelt, die als Sitzmöbel, Tische oder einfache Ablagen verwendet werden können. Hybride Objekte, die mit ihren vielfältigen Verwendungsmöglichkeiten einem Raum Farbe verleihen.

E Esta colección recoge algunos símbolos característicos del lenguaje estilístico de Alessandro Mendini, que se convierten en objetos tridimensionales y pueden utilizarse como asientos, mesitas o elementos de apoyo. Objetos de naturaleza híbrida, capaces de llenar de color cualquier ambiente, están dotados de una gran versatilidad.



Ø 34,5 x h 43 cm

Ø 34,5 x h 43 cm

34,5 x 34,5 x h 43 cm





I_Tre differenti forme realizzate in tecnopolimero. Superfici sia curve che ortogonali in quattro diversi colori per organizzare spazi in continuo divenire. I materiali e la lavorazione consentono l'utilizzo in contesti indoor e outdoor.

EN_Available in three different shapes in technopolymer, they come with curved and orthogonal surfaces in four colours. Perfect for organising dynamic spaces, these pieces are made with durable materials and finishes so they can be used indoors or outdoors.

F_Trois formes différentes en techno polymère. Des surfaces courbes et orthogonales en quatre couleurs différentes pour organiser des espaces en constante évolution. Les matériaux et la fabrication permettent leur emploi aussi bien à l'intérieur qu'à l'extérieur.

D_Drei verschiedene Objekte bestehend aus Technopolymer mit runden als auch rechteckigen Flächen in vier verschiedenen Farben. Perfekt für die Organisation dynamischer Räume. Die dauerhaften Materialien und die Oberflächen ermöglichen den Einsatz in Innen- und Außenbereichen.

E_Tres formas diferentes realizadas en tecnopolímero. Superficies curvas y octogonales que se presentan en cuatro colores distintos para organizar espacios en continua transformación. Los materiales y su elaboración permiten su uso tanto en interior como en exterior.

SHOPPER

Stefano Barzaghi

I Il nome stesso, "Shopper", è un chiaro riferimento alla natura non convenzionale di questa seduta. Si tratta di un pouf che vanta molteplici usi alternativi grazie alle comode maniglie che ne consentono una facile trasportabilità. La quasi "indossabilità" di questo elemento, grazie anche ad un peso decisamente contenuto, lo rende perfetto per riconfigurare velocemente gli spazi.

EN The very name Shopper underlines the unconventional nature of this seat. Designed as a versatile pouf, especially for alternative uses, it has practical handles that make it exceptionally easy to move around. This, together with its lightweight and almost 'wearable' design, makes it ideal for quickly reconfiguring spaces.

F Le nom même, « Shopper », fait clairement allusion à la nature non conventionnelle de ce siège. Il s'agit d'un pouf qui offre de multiples et diverses possibilités d'utilisation grâce à ses poignées pratiques qui permettent de le transporter facilement. Le caractère presque « portable » de cet élément, également grâce à sa légèreté, le rend parfait pour réaménager rapidement les espaces.

D Der Name „Shopper“ ist ein klarer Bezug auf die unkonventionelle Natur dieser Sitze. Dank der praktischen Griffe, die einen einfachen Transport ermöglichen, ist dieser Hocker vielseitig einsetzbar. Auch wegen des sehr geringen Gewichts ist dieses praktische Möbelstück perfekt für eine schnelle Umgestaltung von Räumen.

E Su propio nombre, "Shopper", es una referencia evidente a la índole poco convencional de este asiento. Se trata de un puf que ofrece múltiples usos alternativos gracias a sus cómodas asas, que permiten transportarlo fácilmente. Este elemento, que prácticamente puede "llevarse puesto" gracias a su ligereza, es perfecto para reconfigurar espacios rápidamente.



~ 75 x 75 x h 60 cm



**Sound
absorbing
product**





I_La peculiare granularità dell'imbottitura interna di Shopper garantisce un buon sostegno e comfort alla seduta. Il rivestimento esterno in Snowsound Fiber Textiles arricchisce ancora di più l'oggetto conferendo un potere fonoassorbente. Shopper... molto più che un semplice pouf.

EN_The unique granularity of Shopper's inner padding offers wonderful support and excellent comfort. Its removable outer cover, made from Snowsound Fibre Textiles, adds sound-absorbing properties, enhancing its functionality. Shopper is so much more than just a pouf.

F_La granularité particulière du rembourrage de Shopper assure un bon soutien et un bon confort d'assise. Le revêtement extérieur amovible en Snowsound Fiber Textiles enrichit davantage cet objet en lui conférant un pouvoir d'absorption acoustique. Shopper... beaucoup plus qu'un simple pouf.

D_Die besondere Granularität der Innenpolsterung von Shopper sorgt für guten Halt und komfortables Sitzen. Der abziehbare Bezug aus Snowsound Fiber Textiles bewirkt zusätzliche Funktionalität durch die schallabsorbierende Wirkung. Shopper... mehr als nur ein Sitzkissen.

E_Gracias al peculiar material granular que caracteriza el relleno de Shopper, su asiento ofrece un buen soporte y es garantía de confort. La funda externa extraíble realizada con Snowsound Fiber Textiles enriquece aún más la pieza, dotándola de una capacidad fonoabsorbente. Shopper... mucho más que un simple puf.



100% regenerated nylon - ECONYL®

I_Shopper è disponibile anche con rivestimento in tessuto Snowsound Fiber 12, realizzato in ECONYL®. Materiale ecologicamente sostenibile, nato dalla rigenerazione dei rifiuti di nylon, come reti da pesca o moquette usate. Con il processo ECONYL® si ottiene un materiale rigenerabile all'infinito e con le stesse caratteristiche del nylon vergine.

EN_Shopper is also available with a Snowsound Fiber 12 fabric cover made from ECONYL®, an environmentally sustainable material regenerated from nylon waste, such as fishing nets and used carpets. The ECONYL® process creates an infinitely renewable material with the same properties as virgin nylon.

F_Shopper est également disponible avec une housse en tissu Snowsound Fiber 12, fabriqué en ECONYL®. Il s'agit d'un matériau écologiquement durable, créé à partir de la régénération de déchets de nylon, tels que les filets de pêche ou les moquettes usagées. Grâce au processus ECONYL® on obtient un matériau régénérable à l'infini présentant les mêmes caractéristiques que le nylon vierge.

D_Shopper ist auch mit einem Snowsound Fiber 12-Bezug aus ECONYL® erhältlich. Ein ökologisch nachhaltiges Material, das aus der Regeneration von Nylonabfällen wie Fischernetzen oder gebrauchten Teppichen gewonnen wird. Dank des ECONYL®-Verfahrens wird immer wieder ein regenerierbares Material mit den gleichen Eigenschaften wie ursprüngliches Nylon erzeugt.

E_Shopper también está disponible con exterior en tejido Snowsound Fiber 12, elaborado con ECONYL®. Se trata de un material ecológicamente sostenible, fruto del reciclaje de residuos de nylon, procedente de redes de pesca o moquetas usadas. Mediante el proceso ECONYL® se obtiene un material que puede reciclarse indefinidamente, preservando las mismas características del nylon virgen.

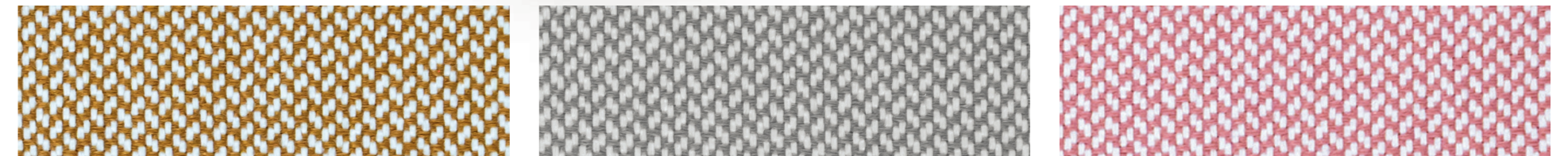
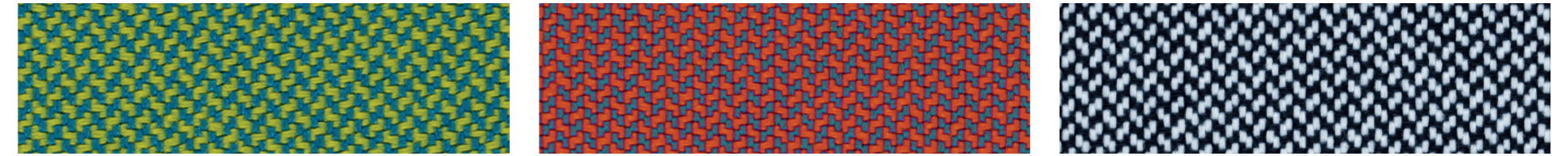
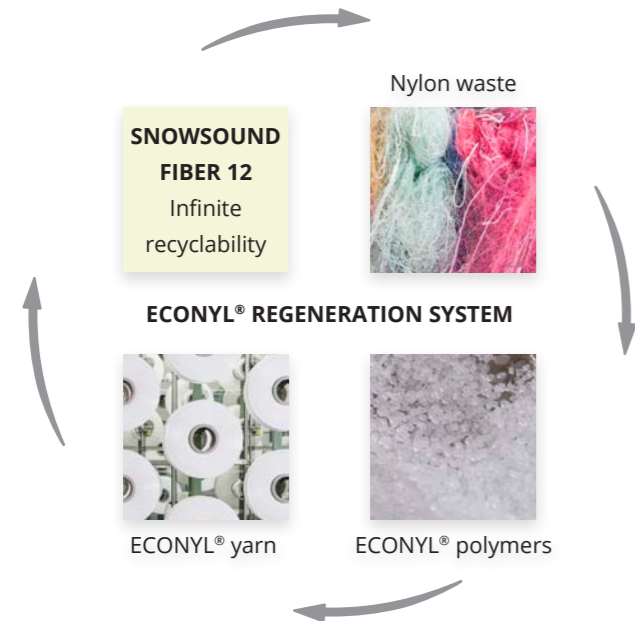

Dividers

I Sistemi di schermi divisori, ideali per suddividere spazi in modo funzionale. Grazie alla loro modularità, possono essere configurati in base alle specifiche esigenze, permettendo una gestione flessibile degli ambienti. Questi elementi permettono di ottimizzare gli spazi, aumentando l'efficienza operativa degli edifici, attraverso soluzioni di design.

EN These screen partition systems are ideal for functional room division. Their modularity ensures customisable configurations that can meet specific needs as part of flexible space management. These elements are ideal for the optimal use of spaces, improving the operational efficiency of buildings through thoughtful design solutions.

F Des systèmes de cloisons idéaux pour subdiviser les espaces de manière fonctionnelle. Grâce à leur modularité, ils peuvent être configurés en fonction de besoins spécifiques, ce qui permet une gestion flexible des espaces. Ces éléments permettent d'optimiser les espaces, en augmentant l'efficacité opérationnelle des immeubles, grâce à des solutions de design.

D Trennwandsysteme, ideal für eine funktionelle Raumaufteilung. Dank ihrer Modularität können sie als Bestandteil eines flexiblen Space Management nach Kundenbedarf zusammengestellt werden. Diese Elemente sind ideal für optimale Raumnutzung, indem sie die operative Effizienz von Gebäuden durch eine planerisch durchdachte Anordnung verbessern.

E Sistemas de mamparas divisorias idóneas para subdividir los espacios de manera funcional. Gracias a su modularidad, pueden configurarse en función de las necesidades específicas, facilitando una gestión flexible de los espacios. Dichos elementos permiten optimizar el ambiente, incrementando así la eficacia operativa de los edificios mediante soluciones de diseño.

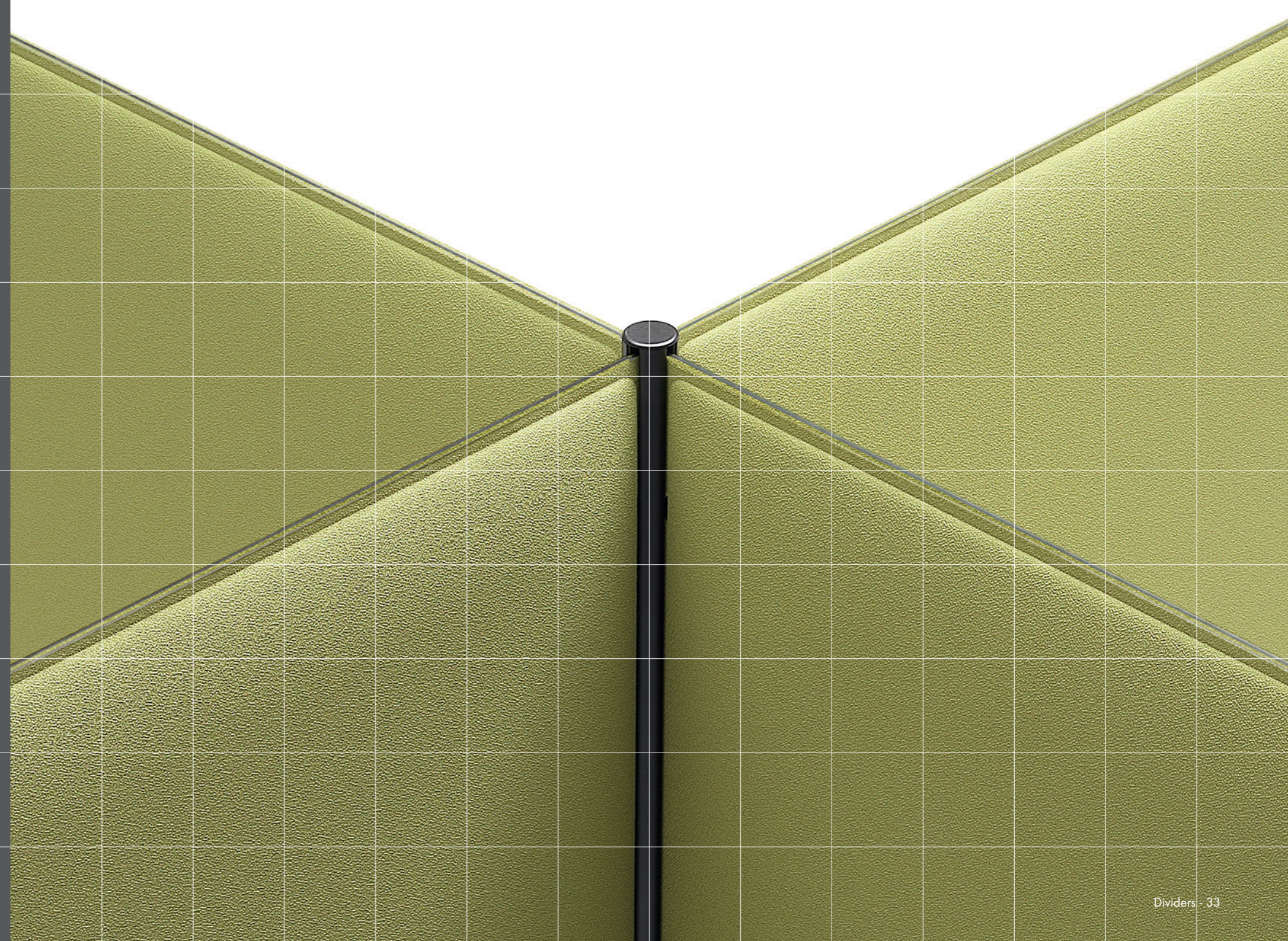

CLIP SI Design

I_Clip è un sistema brevettato di schermi divisori che conferisce modularità alla pluripremiata tecnologia dei pannelli fonoassorbenti Snowsound. Il prodotto sfrutta un montante a quattro vie per organizzare gli spazi attraverso configurazioni personalizzate contraddistinte da elevate performance acustiche. Il sistema è dotato di particolari clip autobloccanti che permettono il fissaggio ad incastro del pannello al montante, senza dover ricorrere a viti o attrezzi specifici. Questo semplifica e velocizza il montaggio.

EN_Clip is a patented screen partition system that adds modularity to Snowsound's award-winning sound absorbing panel technology. Utilising a four-way upright, this product is ideal for custom configurations so as to organise spaces while providing excellent acoustic performance. The system has special self-locking clips that secure the panel to the upright without the need for screws or special tools, simplifying and speeding up installation.

F_Clip est un système breveté de cloisons qui confère un caractère modulaire à la technologie plusieurs fois primée des panneaux acoustiques Snowsound. Ce produit exploite un montant à quatre voies pour organiser les espaces grâce à des configurations personnalisées caractérisées par des performances acoustiques élevées. Ce système est équipé de clips autobloquants spécifiques qui permettent de fixer le panneau en l'emboîtant au montant sans vis ni outils particuliers. Cela simplifie et accélère le montage.

D_Clip ist ein patentiertes Trennwandsystem, das die mehrfach preisgekrönte Akustikpaneel-Technologie von Snowsound modular nutzt. Das Produkt erlaubt es dank seines Vier-Weg-Ständers, Räume je nach Bedarf individuell zu unterteilen und dabei eine exzellente Akustik zu gewährleisten. Das System verfügt über spezielle selbstverriegelnde Clips, mit denen die Platte am Gestell befestigt werden kann, ohne dass Schrauben oder Spezialwerkzeuge benötigt werden. Das vereinfacht und beschleunigt die Montage.

E_Clip presenta un sistema patentado de mamparas divisorias que otorga modularidad a la laureada tecnología Snowsound, que se plasma en los paneles fonoabsorbentes que lo componen. El producto dispone de un montante cuádruple para gestionar los espacios mediante configuraciones personalizadas caracterizadas por un elevado rendimiento acústico. El sistema está equipado con clips autoblocantes especiales que permiten fijar a presión el panel al montante sin utilizar tornillos ni herramientas especiales, lo que simplifica y acelera el montaje.



**Sound
absorbing
panel**









Snowsound Technology - Acoustic performance "A Class"

I La brillante intuizione alla base della tecnologia brevettata Snowsound è l'utilizzo di pannelli composti da materiale a densità variabile, che permette di ottenere un assorbimento selettivo alle diverse frequenze e quindi di ottimizzare l'acustica dell'ambiente nonostante lo spessore molto contenuto dei pannelli. L'assenza di cornici e cuciture e la peculiarità del materiale con cui sono realizzati i pannelli, li rendono estremamente leggeri, poco ingombranti e adattabili ad ogni ambiente.

EN The brilliant intuition at the heart of Snowsound patented technology is based on the use of panels composed of material with variable density, which achieve selective absorption at different frequencies and thus optimise the acoustical environment notwithstanding the thinness of the panels. The absence of frames and seams and the unusual characteristics of the material used in the fabrication of the panels, render them extremely light, unobtrusive and adaptable to any environment.

F La brillante intuition à la base de la technologie brevetée Snowsound pré-voit l'emploi des panneaux en particules à densité variable, qui permet d'obtenir une absorption sélective aux différentes fréquences et par conséquent d'optimiser l'acoustique des espaces, malgré l'épaisseur très mince des panneaux. L'absence de cadres et de coutures et la spécificité du matériel de base en font des panneaux très légers, peu encombrants et qui s'adaptent très bien à tout espace.

D Die Grundlage der patentierten Snowsound Technologie besteht aus der Verwendung von Materialien unterschiedlicher Dichte. Diese Materialien absorbieren die unterschiedlichsten Frequenzbereiche und ermöglichen trotz geringer Materialstärke eine Verbesserung der Raumakustik. Die Snowsound Paneele sind, ohne Rahmen oder Nähte, aus einem Stück gefertigt, besonders leicht und passen sich an jedes Ambiente an.

E La brillante intuición a la base de la tecnología patentada Snowsound es el uso de paneles compuestos por materiales de densidad variable, que permite obtener una absorción selectiva en las diversas frecuencias y entonces optimizar la acústica del ambiente, a pesar del espesor muy reducido de los paneles. La ausencia de marcos y costuras y la peculiaridad del material con el que son realizados los paneles, lo vuelven muy livianos, poco voluminosos y adaptables para todos ambientes.

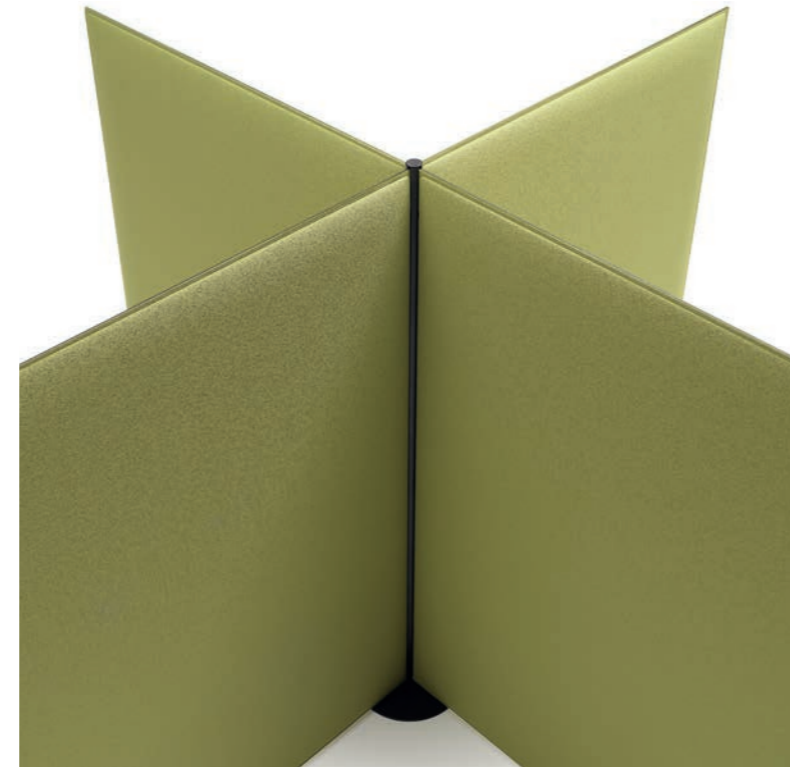

ANDAMENTO DEL COEFFICIENTE DI ASSORBIMENTO ACUSTICO "αs" PER TERZI D'OTTAVA
One-third octave sound absorption coefficient curve "αs"

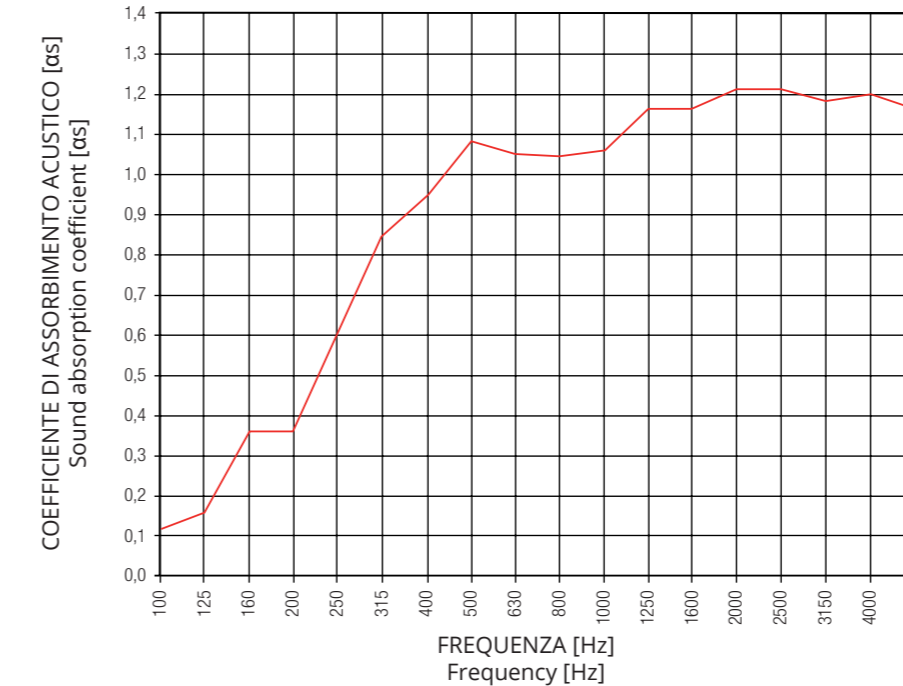

I Misura dell'assorbimento acustico in camera riverberante UNI EN ISO 354 (pannelli Mitesco/Snowsound® installati accostati e con intercapedine d'aria posteriore di 200 mm).

EN UNI EN ISO 354 measures sound-absorbing power in a reverberation room (Mitesco/Snowsound® panels installed side by side and with an 200 mm rear air space).

I I pannelli Snowsound Technology sono stati testati in camera riverberante secondo la norma UNI EN ISO 354 ottenendo la "Classe di Assorbimento Acustico A" in accordo con la norma UNI EN ISO 11654.

EN Snowsound Technology panels were tested in a reverberation room according to UNI EN ISO 354 standards obtaining "Class A sound absorption" to UNI EN ISO 11654 standards.

F Les panneaux Snowsound Technology ont fait l'objet de tests en chambre réverbérante conformément à la norme UNI EN ISO 354, obtenant la "classe d'absorption acoustique A" selon la norme UNI EN ISO 11654.

D Die Snowsound Technology Paneele wurden gemäß der Norm UNI EN ISO 354 in einem Hallraum getestet. Sie erhielten gemäß der Norm UNI EN ISO 11654 die Klassifizierung "Schallabsorption A".

E Los paneles Snowsound Technology se probaron en cámara reverberante conformemente a la norma UNI EN ISO 354 consiguiendo la "Clase A de Absorción Acústica" en virtud de la norma UNI EN ISO 11654.



Sound absorbing panel



Ascolta la differenza (video)



Listent to the difference (video)



Clicca e guarda il video.
Click and watch the video.

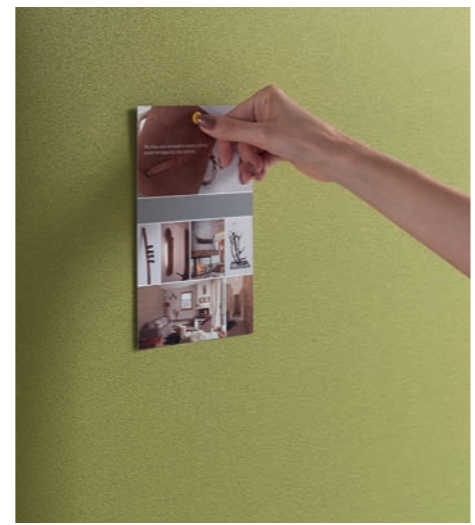
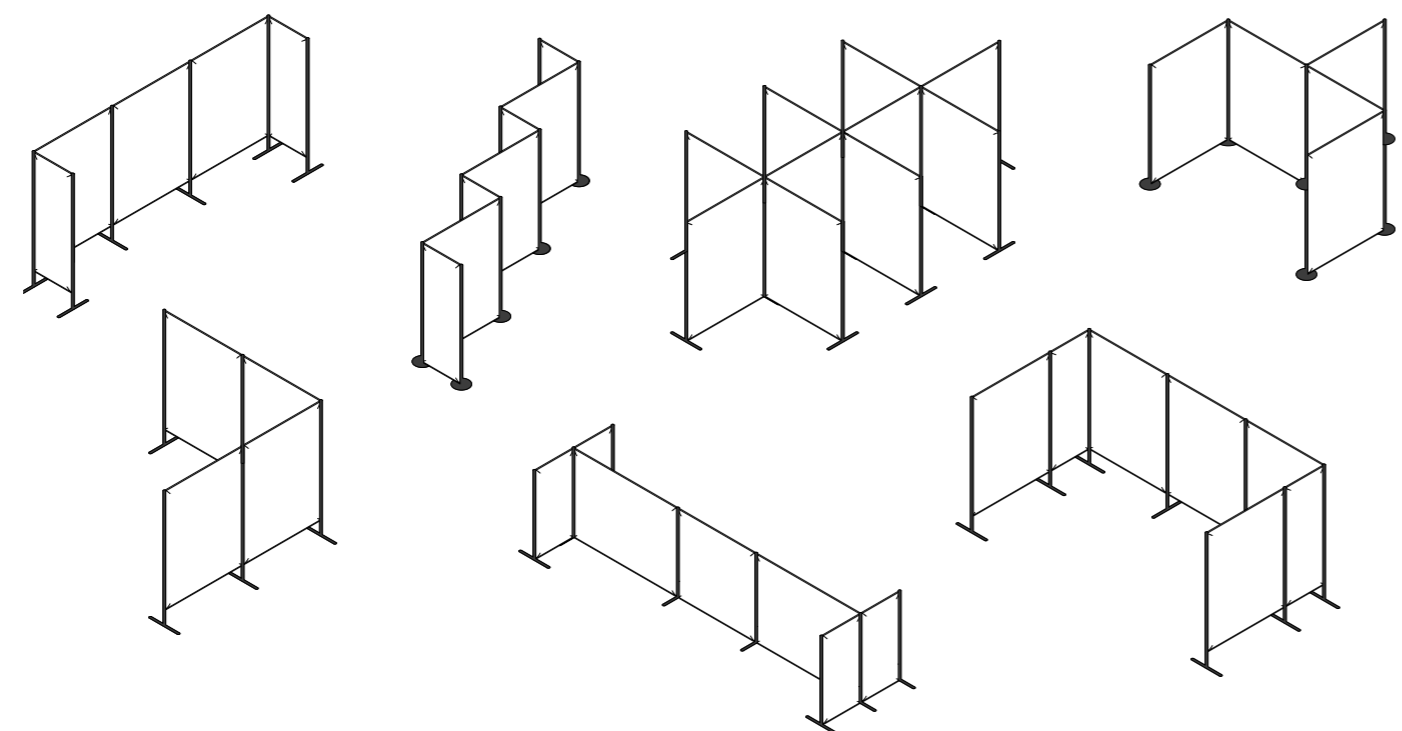

I Montante a 4 vie in alluminio verniciato con polveri epossidiche con base in acciaio verniciato con polveri epossidiche.

EN Four-way upright in epoxy powder coated aluminium with epoxy powder coated steel base.

F Montant quadri directionnel en aluminium peint en époxy avec base en acier peint en époxy.

D Vier-Weg-Ständer aus Aluminium mit Epoxidpulver-Beschichtung mit Sockel auf pulverbeschichteten Stahlfüßen.

E Montante cuádruple de aluminio barnizado con polvos epoxi con base de acero barnizado con polvos epoxi.

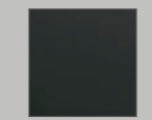
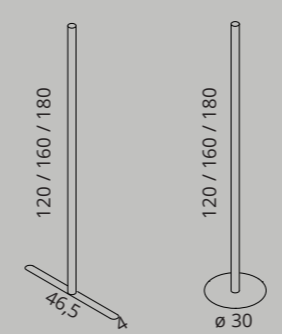

I Pannello con imbottitura interna in poliester a densità variabile Snowsound Technology. Rivestimento esterno in tessuto di poliester Trevira CS.

EN Panel with Snowsound Technology variable-density polyester interior padding. External covering in Trevira CS polyester fabric.

F Panneau avec rembourrage intérieur en polyester à densité variable Snowsound Technology. Revêtement extérieur en tissu polyester Trevira CS.

D Paneel mit Snowsound Technology-Polsterung mit variabler Dichte. Außenverkleidung aus Polyestergewebe Trevira CS.

E Panel con acolchado interior de poliéster de densidad variable Snowsound Technology. Revestimiento exterior en tejido de poliéster Trevira CS.

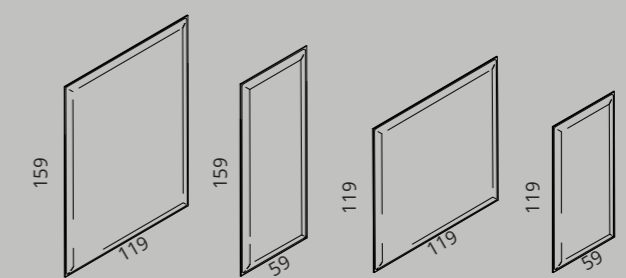

Dimensions in cm

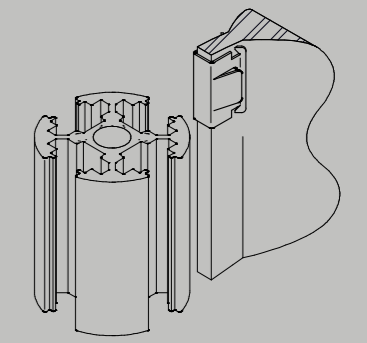
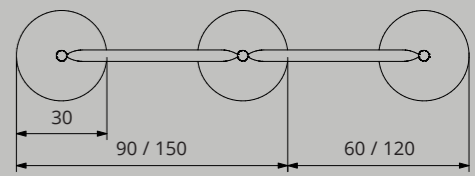
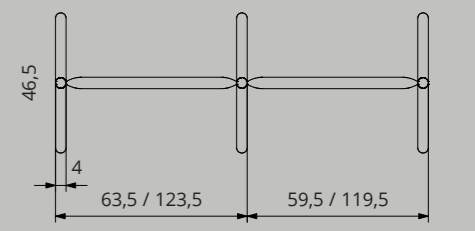

Clicca e guarda il video.
Click and watch the video.



Easy assembly (video)

ARIANNA

Caimi Lab

I_Arianna è un sistema modulare di schermi divisori flessibili. I pannelli sono fissati ai montanti tramite attacchi brevettati realizzati in tecnopolimero.

EN_Arianna is a modular system with flexible partitions. Panels are attached to the posts with patented connectors in high-tech polymer.

F_Arianna est un système modulaire de cloisons flexibles. Les panneaux sont fixés aux poteaux par des joints brevetés réalisés en technopolymère.

D_Arianna ist ein Baukastensystem für flexible Trennwände. Die Paneele werden mit patentierte Verbindungen aus Technopolymer angebracht.

E_Arianna es un sistema expansible de mamparas flexibles. Los paneles van fijados a los montantes a través de juntas de tecnopolímero patentadas .





I_Basi in acciaio e montanti in tondino d'acciaio verniciato con polveri epossidiche con tappo superiore in tecnopolimero traslucido. Disponibili in colore bianco opaco.

EN_Epoxy powder-coated steel bases and steel rod uprights with upper cap in translucent high-tech polymer. Available in mat white.

F_Bases en acier et poteaux en rond d'acier peint époxy avec protection supérieure en techno-polymère translucide. Disponibles en blanc mat.

D_Bodenplatte aus mit Epoxypulver beschichtetem Stahl und Standsäule aus mit Epoxypulver beschichtetem Rundstahl mit oberer Abdeckung aus transparentem Technopolymer. Erhältlich in mattweiß.

E_Bases de acero y montantes en redondo de acero pintado con polvos epoxi con tapón superior de tecnopolímero traslucido. Disponible en color blanco mate.

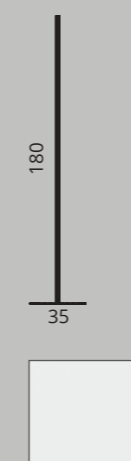

I_Schermi divisori in policarbonato flessibile bisatinato.

EN_Partition screens in double satin finish flexible polycarbonate.

F_Cloisons en polycarbonate souple satiné double faces.

D_Trennwände aus flexiblem beidseitig satiniertem Polykarbonat.

E_Paneles divisorios de policarbonato flexible bisatinado.

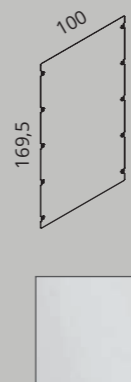

Dimensions in cm

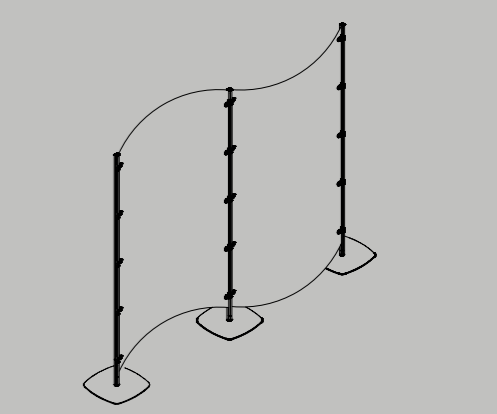
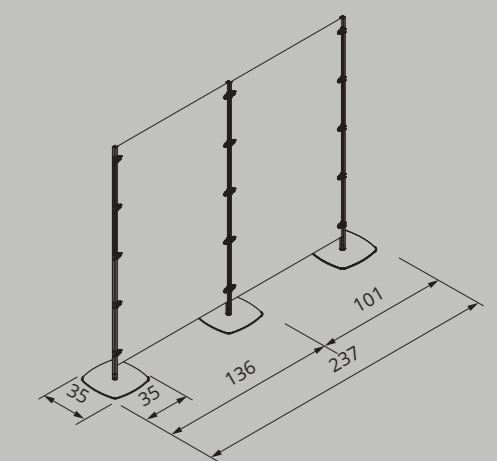

Recycling

I La raccolta differenziata è un'azione fondamentale per la sostenibilità ambientale e sociale, poiché promuove un utilizzo responsabile delle risorse naturali. Le nostre soluzioni per la raccolta differenziata sono pensate per integrarsi armoniosamente in diversi ambienti unendo design, praticità e cura dei dettagli, rendendo semplice e gratificante la partecipazione a questo gesto ecologico.

E Separate waste collection is at the heart of environmental and social sustainability as it promotes the responsible use of natural resources. Our recycling solutions deliberately blend harmoniously into a variety of environments by combining design, practicality and attention to detail, making it easy and rewarding to be part of a greener world.

F La collecte sélective est une action fondamentale pour la durabilité environnementale et sociale, puisqu'elle favorise l'utilisation responsable des ressources naturelles. Nos solutions pour le tri des déchets sont conçues pour s'intégrer harmonieusement dans différents milieux en combinant design, praticité et attention aux détails, ce qui fait de ce geste écologique une action simple et gratifiante.

D Mülltrennung ist ein grundlegendes Element für die ökologische und soziale Nachhaltigkeit, indem sie einen verantwortungsvollen Umgang mit den natürlichen Ressourcen fördert. Unsere Lösungen für die Mülltrennung sind so konzipiert, dass sie sich harmonisch in verschiedene Räumlichkeiten einfügen, indem sie Design, Zweckmäßigkeit und Liebe zum Detail miteinander verbinden. Die Mülltrennung ist somit ein einfacher und lohnender Weg in eine grünere Umwelt.

E La recogida selectiva de residuos fomenta un uso responsable de los recursos naturales, por lo que resulta esencial para alcanzar la sostenibilidad, tanto medioambiental como social. Nuestras soluciones para la recogida selectiva de residuos están proyectadas para integrarse de manera armoniosa en entornos diversos, conciliando el diseño, el sentido práctico y la atención al detalle, y consiguiendo que participar en este gesto ecológico resulte sencillo y gratificante.

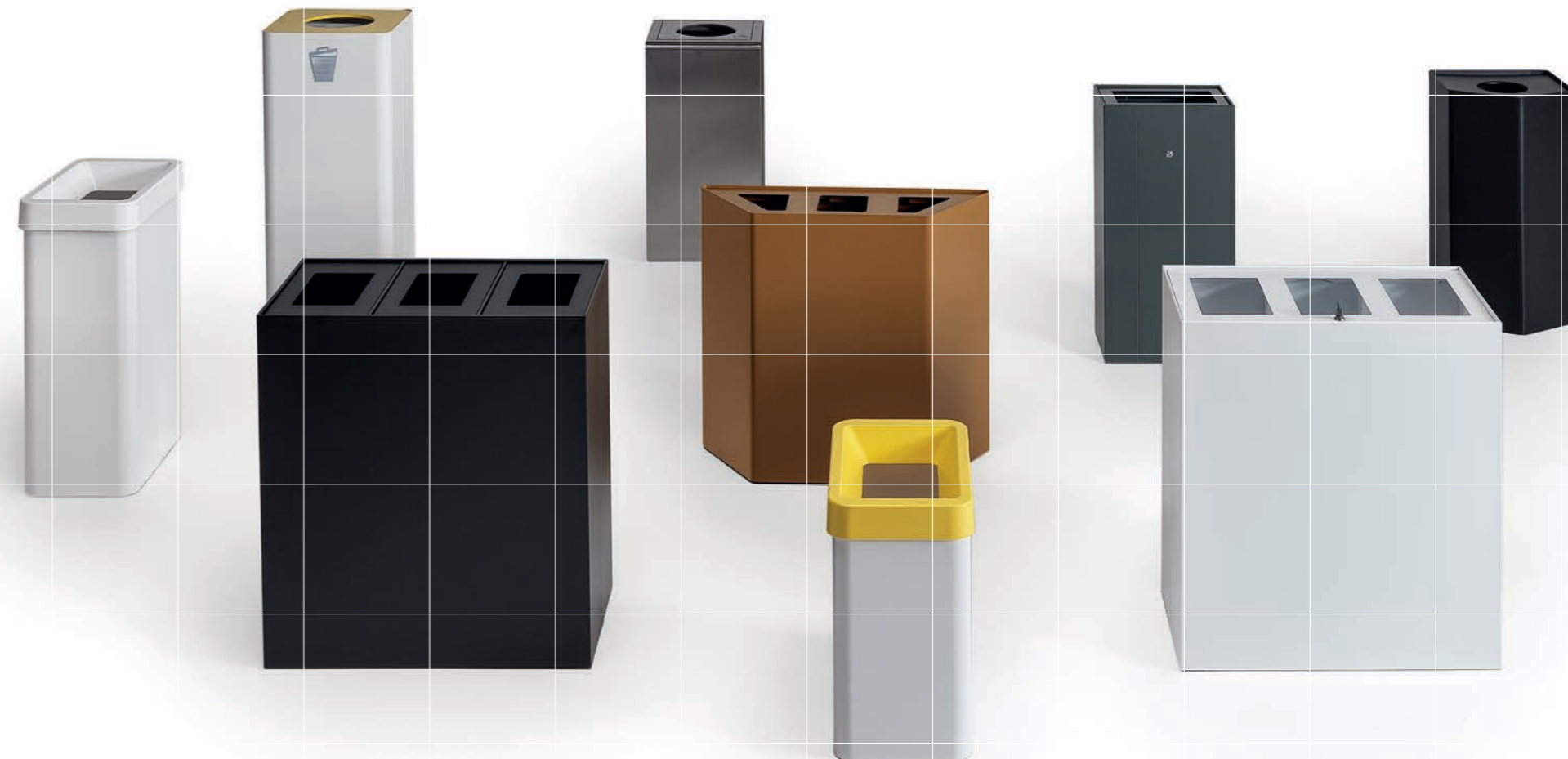

LINEAR

Caimi Lab

I Contenitore in acciaio verniciato con polveri epossidiche. La peculiare geometria ne consente un uso sia in appoggio a parete, molto discreto e non ostacolante, sia in configurazioni con più elementi per la creazione di "isole" dedicate alla raccolta differenziata. Tre colorazioni specifiche aggiungono piacevoli dettagli cromatici sfruttando anche coperchi con tinte abbinata o a contrasto.

E Steel container in epoxy powder coating. Its peculiar geometry allows it to be used either against a wall, very discreet and unobtrusive, or in configurations with several elements for the creation of 'islands' dedicated to waste collection. Three specific colours add attractive chromatic details with the option of matching or contrasting lids.

F Conteneur en acier peint en époxy. Sa géométrie particulière permet à la fois une utilisation près du mur, très discrète et ne gênant pas le passage et des configurations avec plusieurs éléments pour la création d'« îlots » dédiés à la collecte sélective des déchets. Trois couleurs spécifiques ajoutent des détails chromatiques agréables en exploitant également les couvercles de couleurs assorties ou en contraste.

D Stahlbehälter mit Epoxidpulver-Lackierung. Durch seine einzigartige geometrische Form kann er sowohl diskret und unauffällig an der Wand angebracht als auch mit anderen Elementen kombiniert werden, um „Inseln“ für die Mülltrennung zu schaffen. Die drei Farbvarianten sorgen für attraktive farbige Effekte, mit der Option auf Abdeckungen in farblich passenden oder kontrastierenden Farbtönen.

E Contenedor de acero barnizado con polvos epoxi. Su peculiar geometría permite situarlo tanto cerca de la pared, de manera que pasa prácticamente desapercibido, como en configuraciones formadas por varios elementos para crear "islas" dedicadas a la recogida selectiva de residuos. Tres tonalidades diferentes enriquecen los matices cromáticos, jugando también con las tapaderas disponibles en colores combinados o en contraste.



69 x 25 x h 65 cm
3x30 L = 90 L





BINZ

Sezgin Aksu

I_Contenitore a pianta pentagonale realizzato in acciaio verniciato con polveri epossidiche. Elemento dalla spiccata modularità con cui organizzare la raccolta differenziata.

E_This pentagonal container is made of steel and painted with epoxy powders. It is a highly modular unit making it ideal for the optimal organisation of a separate waste collection system.s.

F_Conteneur pentagonal en acier peint en époxy. Un élément résolument modulaire pour organiser la collecte sélective des déchets.

D_Fünfeckiger Stahlbehälter mit Epoxidpulver-Beschichtung. Ein modulares Element, mit dem die Mülltrennung optimal organisiert werden kann.

E_Contenedor en forma pentagonal realizado en acero barnizado con polvos epoxi. Destaca la modularidad con la que el elemento permite organizar la recogida selectiva de residuos.



35 x 35 x h 70 cm
70 L



MAXI Caimi Lab

I_Cestini ideati per la raccolta differenziata, il fusto e la base sono realizzati in acciaio verniciato con polveri epossidiche e sono dotati di coperchio asportabile in tecnopolimero disponibile in vari colori.

E_Bins designed for waste recycling, drum and the base are made from epoxy powder-coated steel: they are equipped with removable cover made from technopolymer available in various colours.

F_Corbeilles conçues pour le tri des déchets, le fût et la base sont en acier peint époxy. Elles sont munies d'un couvercle amovible en technopolymère disponible en plusieurs couleurs.

D_Abfallsammler für die Mülltrennung. Korpus und Boden bestehen aus epoxypulverlackiertem Stahl, zudem verfügen sie über einen entfernbaren Kunststoffdeckel in verschiedenen Farben.

E_Cestos para la separación de residuos, el bidón y la base son de acero pintado con polvo epoxi y están dotados de una tapa removible de tecnopolímero, disponible en varios colores.



42 x 27 x h 50 / 70 / 85 cm
50 L / 70 L / 85 L



MAXIMO Caimi Lab

I_Cestino ideato per la raccolta differenziata interamente realizzato in acciaio verniciato con polveri epossidiche, dotato di coperchi ribaltabili e reggisacchetto asportabile.

EN_A bin, designed for separate waste collection made entirely of epoxy powder-coated steel, with hinged lids and a removable inner bucket.

F_Corbeille conçue pour le tri sélectif des déchets, réalisée entièrement en acier peint en époxy, munie de couvercles rabattables et d'un porte-sachet amovible.

D_Ein idealer Behälter für Mülltrennung, gänzlich aus pulverbeschichtetem Stahl hergestellt, mit Klappdeckel und abnehmbarem Sackhalter.

E_Contenedor concebido para la recogida selectiva de residuos realizado en acero pintado con polvos epoxi, equipado con tapa basculante y con soporte para bolsa extraíble.

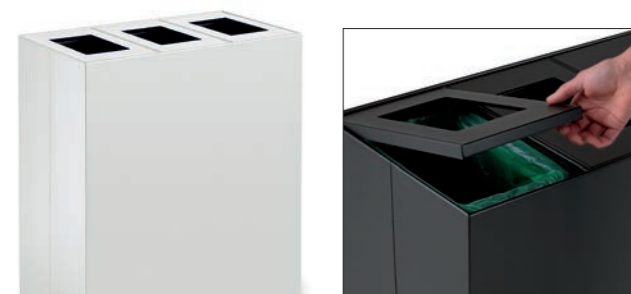

62 x 35 x h 72 cm
3x50 = 150 L



MAXIMO Lock Caimi Lab

I_Versione a coperchio unico, dotato di serratura e chiave per garantire l'apertura al solo personale autorizzato.

EN_The single lid version comes with a lock and key to ensure only authorised personnel can open the lid.

F_Version à couvercle unique, équipée d'une serrure et d'une clé pour garantir l'ouverture uniquement au personnel autorisé.

D_Version mit einem einzigen Deckel, der mit einem Schloss versehen ist, um zu gewährleisten, dass der Behälter nur von befugtem Personal mit Schlüssel geöffnet werden kann.

E_Versión dotada de una única tapadera, que dispone de cerradura y llave para garantizar que la apertura se realice solo por parte del personal autorizado.



62 x 35 x h 72 cm
3x50 = 150 L



MAXIMO Modular Caimi Lab

I Contenitore singolo in acciaio verniciato con polveri epossidiche. Più elementi possono essere fissati l'uno all'altro attraverso viti consentendo di creare un unico elemento con il numero di contenitori necessari per la specifica raccolta differenziata. Due colorazioni disponibili.

EN This single epoxy powder coated steel container is designed for versatility. Multiple units can be easily joined together to create a single unit tailored to specific waste management needs. It is available in two colour options.

F Conteneur individuel en acier peint en époxy. Plusieurs éléments peuvent être fixés les uns aux autres à l'aide de vis, permettant de créer un élément unique avec le nombre de conteneurs nécessaires à la collecte spécifique des déchets. Disponible en deux couleurs.

D Einzelner Stahlbehälter mit Epoxidpulver-Beschichtung. Mehrere Elemente können mittels Schrauben miteinander verbunden werden, sodass eine Einheit aus der für die jeweilige Mülltrennung erforderlichen Anzahl von Behältern gebildet werden kann. In zwei Farben verfügbar.

E Contenedor único en acero barnizado con polvos epoxi. Es posible anclar varios elementos entre sí utilizando tornillos que permiten crear una pieza única dotada del número de contenedores necesarios para la recogida selectiva de residuos. Disponible en dos colores.



24 x 35 x h 72 cm
60 L

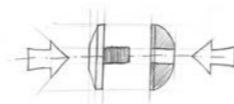
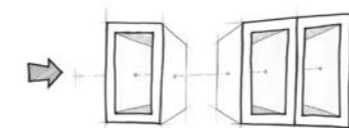

CENTOLITRI

Caimi Lab

I_Cestini ideati per la raccolta differenziata interamente realizzati in acciaio verniciato con polveri epossidiche, dotati di coperchio e reggisacchetto ribaltabili.

EN_Bins projected for waste separation, entirely made in epoxy powder-coated steel, with folding lid and liner holder.

F_Corbeilles pour le tri sélectif des déchets réalisées entièrement en acier peint en époxy, avec couvercle et support sac basculants.

D_Abfallsammler, die für die Mülltrennung entworfen wurden, ganz aus pulverbeschichtetem Stahl, mit Klappdeckel und -Müllsackhalter.

E_Cestos diseñados para recogida selectiva totalmente realizados en acero pintado con polvos epoxi, equipados con tapa y sujeta bolsas basculantes.



35 x 35 x h 85 cm
100 L





CENTOLITRI Lock Caimi Lab

I_Cestino ideato per la raccolta differenziata interamente realizzato in acciaio verniciato con polveri epossidiche con sportello anteriore totalmente apribile che velocizza e semplifica le operazioni di svuotamento e sostituzione. Dotato di serratura e chiave per garantire l'apertura al solo personale autorizzato.

EN_This recycling collection bin made entirely of epoxy powder coated steel has a fully opening front section for easy emptying and bag replacement. It is also fitted with a lock and key mechanism to restrict access to authorised personnel only.

F_Corbeille conçue pour la collecte sélective des déchets, entièrement en acier peint en époxy, avec une porte frontale à ouverture totale qui accélère et simplifie les opérations de vidage et de remplacement. Équipée d'une serrure et d'une clé pour garantir l'ouverture uniquement au personnel autorisé.

D_Abfallbehälter aus Stahl mit Epoxidpulver-Beschichtung für die Mülltrennung, dessen vollständig zu öffnender Fronttür die Entleerung und das Auswechseln des Müllsacks beschleunigt und vereinfacht. Schloss und Schlüssel gewährleisten, dass der Behälter nur von befugtem Personal geöffnet werden kann.

E_Papelera concebida para la recogida selectiva de residuos y realizada íntegramente en acero barnizado con polvos epoxi. La parte delantera funciona como una puerta que permite una apertura completa para acelerar y simplificar las operaciones de vaciado y sustitución de la bolsa. Dispone de cerradura y llave para garantizar que la apertura se realice solo por parte del personal autorizado.



35 x 35 x h 85 cm
100 L



PRISMA

Sezgin Aksu, Silvia Suardi

Innovativo ed elegante sistema di accessori contenitori, formato da portaombrelli per ombrelli a bastone o pieghevoli, posacenere, gettacarte e fioriere, realizzati interamente in acciaio inossidabile. Disponibili anche interamente realizzati in acciaio inossidabile AISI 304 adatti per l'utilizzo in esterno con fondo appositamente forato per far defluire l'acqua piovana e predisposizione per il fissaggio a terra.

EN Innovative and elegant line of containers, consisting of umbrella stands for long or foldable umbrellas, ashtrays, waste bins and planters, all made entirely of stainless steel. Also available made entirely of AISI 304 stainless steel, suitable for external use, equipped with perforated base for the drainage of rainwater, especially designed for being fixed to the ground.

F Système innovant et élégant d'accessoires-bacs, constitué de porte-parapluies, pour parapluies normaux et pliables, cendriers, corbeilles à papier et jardinières, entièrement réalisés en acier inoxydable. Disponibles aussi entièrement en acier inoxydable AISI 304 prévus pour l'utilisation à l'extérieur avec base forée pour faire couler l'eau de pluie et prévue pour la fixation au sol.

D Innovatives und elegantes Behältersystem aus einem Schirmständer für Lang- und Taschenschirme, Aschenbecher, Papierkorb und Blumenkübel, komplett aus rostfreiem Stahl. Auch vollständig aus rostfreiem Stahl AISI 304 für die Verwendung in Außenbereichen mit speziell gelochtem Boden für den Abfluss des Regenwassers und Möglichkeit zur Bodenbefestigung erhältlich.

E Un innovador y elegante sistema de accesorios contenedores formado por paragueros para paraguas clasicos como para los plegables, ceniceros, papeleras y macetas. Disponible tambien completamente de acero inoxidable AISI 304 aptos para su uso en exterior con un fondo perforado para dejar que pase el agua de lluvia. Puede fijarse al suelo.

34 x 35 x h 35 / 50 / 70 cm







GRAPHICS

I_Grafiche adesive in tecnopolimero.

EN_Adhesive graphics in technopolymer.

F_Graphiques autocollantes en high-tech polymer.

D_Kleber aus technischem Kunststoff mit Grafiken.

E_Gráficas adhesivas de tecnopolímero.



Accessories

I I nostri accessori non sono solo complementi d'arredo di alta qualità, ma veri e propri elementi che trasformano gli ambienti. Ogni pezzo è pensato per unire piacevolezza estetica, praticità e cura del dettaglio, garantendo quindi un comfort tangibile, fondamentale in tutti quegli spazi che ambiscono alla promozione del benessere dei loro occupanti.

EN Our accessories are much more than just quality furnishings; they are transformative elements for spaces. Each piece combines aesthetic appeal, practicality and attention to detail, providing the tangible comfort essential for spaces where people's well-being is paramount.

F Nos accessoires ne sont pas seulement des compléments d'ameublement de qualité, mais de véritables éléments qui transforment les espaces. Chaque unité est conçue pour allier plaisir esthétique, praticité et souci du détail, garantissant ainsi un confort tangible, essentiel dans tous les espaces qui visent à promouvoir le bien-être de leurs occupants.

D Unser Zubehör umfasst nicht nur hochwertige Einrichtungsgegenstände, sondern Elemente, die Räume grundlegend verwandeln. Jedes Stück ist so konzipiert, dass es Ästhetik, Zweckmäßigkeit und Liebe zum Detail miteinander verbindet und so in allen Räumen für spürbaren Komfort und persönliches Wohlbefinden sorgt.

E Nuestros accesorios no solo son complementos de decoración de elevada calidad, sino que se trata de elementos que consiguen transformar realmente el entorno que los rodea. Cada pieza está concebida para conciliar el aspecto estético, el sentido práctico y la atención a los detalles, y para garantizar un confort tangible, esencial en aquellos espacios que aspiran a propiciar el bienestar de quien los habita.



LUTHEA

Alessandro Zambelli

I Portabiti a piantana realizzato in acciaio e zama verniciati con polveri epossidiche. Disponibile in due versioni rispettivamente dotate di 3 ganci e 3 pomoli, oppure 6 ganci e 6 pomoli. I supporti si innestano perpendicolarmente al montante seguendo uno sviluppo elicoidale asimmetrico che conferisce dinamicità all'oggetto.

EN This coat stand in steel and zamak, coated with epoxy powder, is available in two versions: one with 3 hooks and 3 rounded pegs and another with 6 hooks and 6 rounded pegs. The supports attach perpendicularly to the upright and have an asymmetrical spiral design that gives the object a dynamic sense.

F Portemanteau fabriqué en acier et zamak, peint en époxy. Disponible en deux versions, respectivement à 3 crochets et 3 patères, ou à 6 crochets et 6 patères. Les supports s'emboîtent perpendiculairement au montant grâce à un agencement hélicoïdal asymétrique qui dynamise l'objet.

D Kleiderständer aus Stahl und Zamak mit Epoxidpulver-Beschichtung. Erhältlich in zwei Versionen mit jeweils 3 Haken und 3 Knöpfen oder 6 Haken und 6 Knöpfen. Die Kleiderhaken sind rechtwinklig am Ständer angebracht, und verlaufen asymmetrisch spiralförmig, wodurch dem Objekt Dynamik verliehen wird.

E Perchero de pie realizado en acero y zamak, y barnizado con polvos epoxi. Disponible en dos versiones dotadas de 3 ganchos y 3 pomos o de 6 ganchos y 6 pomos, respectivamente. Los colgadores se insertan perpendicolarmente en el tronco, generando un desarrollo helicoidal asimétrico que confiere dinamismo a la pieza.



ø 30 x h 160 cm



ø 30 x h 160 cm





I_DESIGN INCLUSIVO

Questo oggetto è un esempio di design inclusivo. L'appendiabiti con 6 ganci e 6 pomoli è pensato per essere facilmente utilizzabile anche da persone con mobilità ridotta o di bassa statura. I supporti inferiori sono infatti raggiungibili da utenti in sedia a rotelle o bambini, quindi indipendentemente dall'abilità, età o background dell'utilizzatore. Si tratta di piccoli, semplici dettagli che fanno la differenza per moltissime persone.

EN_INCLUSIVE DESIGN

This piece is an example of inclusive design. The 6-hook, 6-peg coat stand is designed to be accessible to people with reduced mobility or short stature. For example, its lower supports are designed to be accessible to wheelchair users or children, ensuring usability regardless of the user's capability, age or background. These details make a significant difference in improving accessibility and usability for many people.

F_DESIGN INCLUSIF

Cet objet est un exemple de design inclusif. Le portemanteau à 6 crochets et 6 patères est conçu pour être facilement utilisable même par des personnes à mobilité réduite ou de petite taille. En effet, les supports inférieurs peuvent être atteints par des personnes en fauteuil roulant ou par des enfants, quels que soient les capacités, l'âge ou les acquis de l'utilisateur. Ce sont de simples détails qui font toute la différence pour de nombreuses personnes.

D_INKLUSIVES DESIGN

Dieses Objekt ist ein Beispiel für inklusives Design. Der Kleiderständer mit 6 Haken und 6 Knöpfen ist so aufgebaut, dass es auch problemlos von Personen mit eingeschränkter Mobilität oder kleiner Statur genutzt werden kann. Die unteren Haken sind auch für Rollstuhlfahrer*innen oder Kinder erreichbar, und können somit von Menschen unabhängig von Behinderungen, Alter oder anderen Kriterien genutzt werden. Diese kleinen, einfachen Details bedeuten vielen Menschen mehr Zugänglichkeit und bessere Nutzbarkeit.

E_DISEÑO INCLUSIVO

Este objeto constituye un ejemplo de diseño inclusivo. Se trata de perchero dotado de 6 ganchos y 6 pomos, concebido para ser utilizado fácilmente por personas con movilidad reducida o de baja estatura. De hecho, los colgadores situados en la parte inferior están al alcance de personas en silla de ruedas o de niños, accesibles para todos los usuarios, independientemente de sus capacidades, edad u otras circunstancias. Pequeños y sencillos detalles que marcan la diferencia para un elevado número de personas.

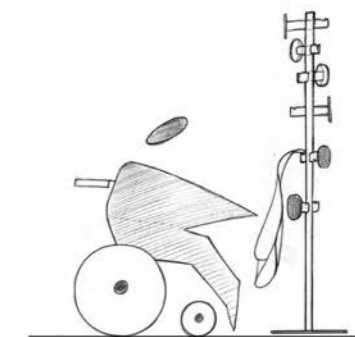
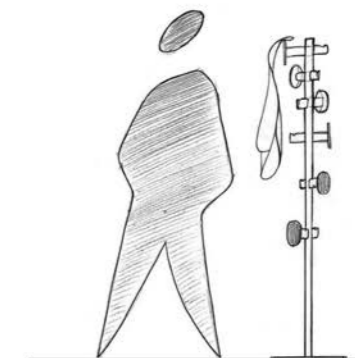
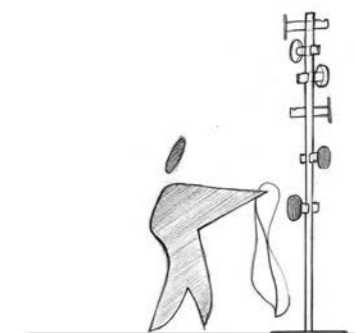

STELLA

Atelier Mendini

I Portabiti a piantana realizzati in acciaio verniciato con polveri epossidiche. Pomoli in ottone e viti in acciaio dorato.

EN Coat stand in powder-coated steel. Brass handles and decorative gold plated steel screws.

F Portemanteau sur pied réalisé en acier verni avec poudres époxy. Pommeaux en laiton et vis en acier doré.

D Garderobenständer aus Stahl mit Epoxidpulverlackierung. Knöpfe aus Messing und Schrauben aus vergoldetem Stahl.

E Percheros de pie de acero recubierto con polvos epoxi. Pomelos de latón y tornillos de acero dorado.



35 x 35 x h 179 cm



MET'ALL

Sezgin Aksu

I_Portabiti a piantana interamente in metallo. Testa in zama e tubo centrale in acciaio cromato o verniciato con polveri epossidiche. Base in acciaio verniciato con polveri epossidiche o in acciaio inox lucido.

EN Standing coat stand. Head in zamak and central post in chrome-plated or powder-coated steel. Powder-coated steel or polished stainless steel base.

F_Portemanteau sur pied entièrement en métal. Tête en zamak et tube central en acier chromé ou peint en époxy. Base en acier peint en époxy ou en acier inox brillant.

D_Vollständig aus Metall gefertigter Garderobenständer. Kopf aus Zamak und Standsäule aus verchromtem oder pulverbeschichtetem Stahl. Fuß aus Stahl mit Epoxidpulverlackierung oder aus poliertem Edelstahl.

E_Perchero de pie realizado en metal. Cabezal de zamak y cilindro central de acero cromado o pintado con polvos epoxi. Base de acero recubierta con polvos epoxi o en acero inox brillante.



Ø 30 x h 163 cm





SWING

Claudio Bellini

I Portabiti a piantana con struttura in acciaio verniciato con polveri epossidiche. Teste in policarbonato. Anello portaombrelli e vaschetta raccogliogocce asportabili in tecnopolimero.

EN Coat stands with stem in epoxy painted steel. Heads in polycarbonate. Removable umbrella ring and drip tray in high-tech polymer.

F Portemanteau avec corps en acier peint en époxy. Têtes en polycarbonate. Anneau porte-parapluies et réceptacle amovibles en techno-polymère.

D Garderobenständer mit Standsäule aus pulverbeschichtetem Stahl. Kopfteil aus Polykarbonat. Demontierbare Schirmhalterung und Abtropftasse aus Technopolymer.

E Perchero de pie con estructura en acero pintado con polvos epoxídicos. Cabezas en policarbonato. Aro paraguero y cubeta recoge aguas exportables en tecnopolímero.



ø 39 x h 167 cm



QUADRANGOLO

Sezgin Aksu, Silvia Suardi

I_Portabiti a piantana con tubo centrale a sezione quadrata e base realizzati in acciaio verniciato con polveri epossidiche finitura bianco opaco o verniciato finitura legno. La testa è realizzata in policarbonato finitura bianco opaco.

EN_Coat stand with a central, square-section tube and base carried out in powder-coated steel, mat white finish or paint wood finish. The head is in mat white polycarbonate.

F_Portemanteau avec tube central à section carrée et base réalisés en acier peint époxy, finition blanc mat ou peint finition bois. La tête est en polycarbonate, finition blanc mat.

D_Garderobenständer mit quadratischer Standsäule und Bodenplatte aus pulverbeschichtetem Stahl in mattweiß oder Holzdekor. Der Kopf ist aus Polycarbonat, mit weiß-mattem Finish.

E_Percheros de pie con tubo central de sección cuadrada y base de acero pintado con polvo epoxi acabado blanco mate o pintado acabado madera. La cabeza es de policarbonato acabado blanco mate.



35 x 35 x h 154 cm



GIOIA

I_Portabiti a piantana con struttura in acciaio verniciato con polveri epossidiche. Teste in policarbonato. Anello portaombrelli e vaschetta raccogliocce asportabili in tecnopolimero.

EN_Coat stands with stem in epoxy painted steel. Heads in polycarbonate. Removable umbrella ring and drip tray in high-tech polymer.

F_Portemanteaux avec corps en acier peint en époxy. Têtes en polycarbonate. Anneau porte-parapluies et réceptacle emportables en techno-polymère.

D_Garderobenständer mit Standsäule aus pulverbeschichtetem Stahl. Kopfteil aus Polykarbonat. Demontierbarer Schirmhalterung und Abtropfasse aus Technopolymer.

E_Perchero de pie con estructura en acero pintado con polvos epoxídicos. Cabezas en policarbonato. Aro paragüero y cubeta recoge aguas exportables en tecnopolímero.



ø 39 x h 167 cm

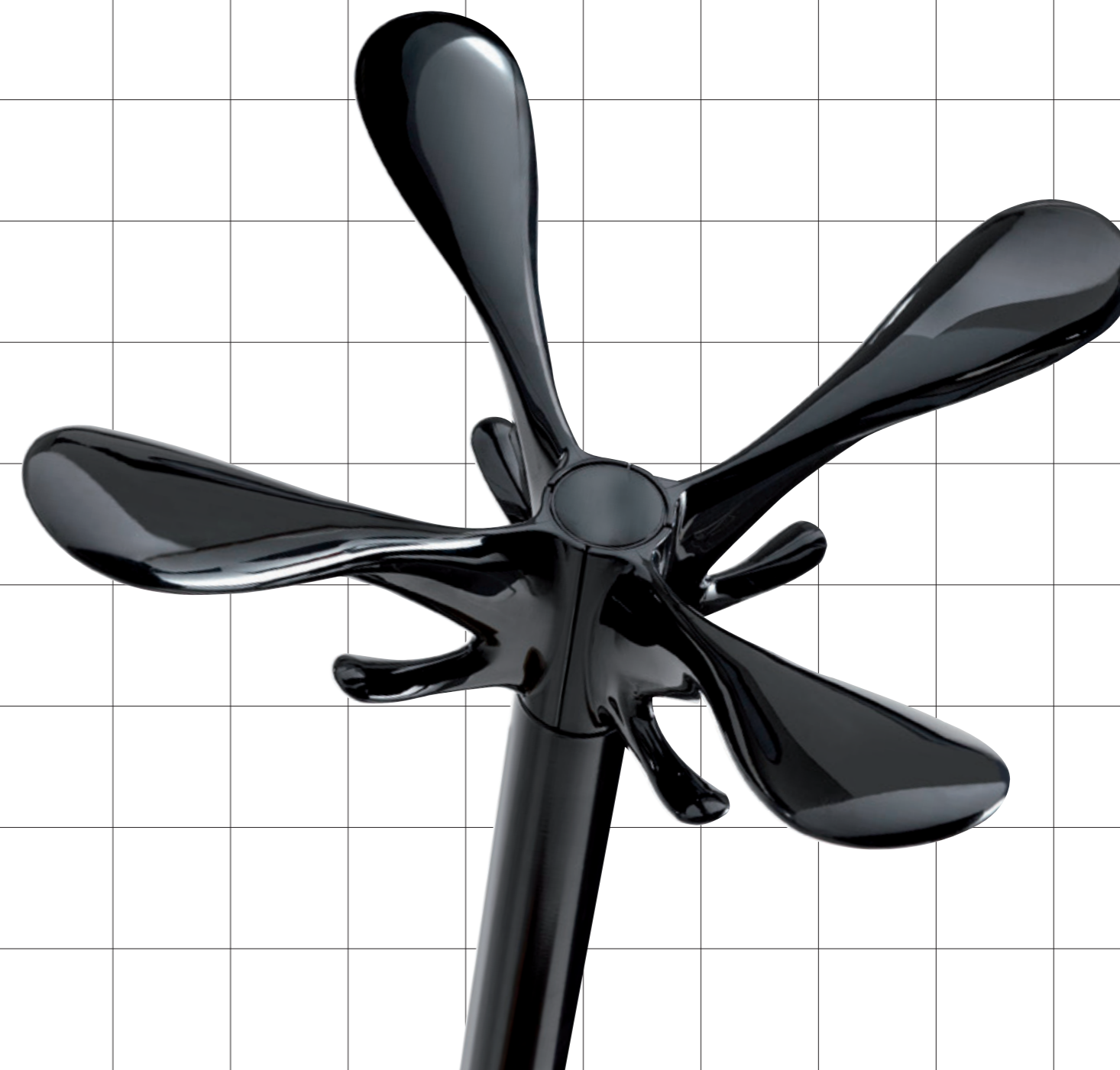

ELK

Angelotti & Cardile

I_Portabiti a piantana con struttura in acciaio verniciato con polveri epossidiche. Teste in tecnopolimero. Anello portaombrelli e vaschetta raccogliogocce asportabili in tecnopolimero.

EN_Coat stands with stem in epoxy painted steel. Heads in high-tech polymer. Removable umbrella ring and drip tray in high-tech polymer.

F_Portemanteaux avec corps en acier peint en époxy. Têtes en techno-polymère. Anneau porte-parapluies et réceptacle amovibles en techno-polymère.

D_Garderobenständer mit Standsäule aus pulverbeschichtetem Stahl. Kopfteil aus Technopolymer. Demontierbare Schirmhalterung und Abtropfasse aus Technopolymer.

E_Perchero de pie con estructura en acero pintado con polvos epoxídicos. Cabezas en tecnopolímero. Aro paraguero y cubeta recoge aguas exportables en tecnopolímero.

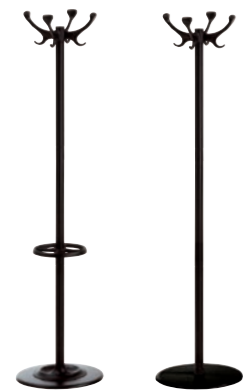

ø 39 x h 167 cm



EVA Caimi Lab

I_Portabiti a piantana con struttura in acciaio verniciato con polveri epossidiche. Teste in tecnopolimero. Anello portaombrelli asportabile in tecnopolimero.

EN_Coat stands with stem in epoxy painted steel. Heads in high-tech polymer. Removable umbrella ring in high-tech polymer.

F_Portemanteaux avec corps en acier peint en époxy. Têtes en techno-polymère. Anneau porte-parapluies amovibles en techno-polymère.

D_Garderobenständer mit Standsäule aus pulverbeschichtetem Stahl. Kopfteil aus Technopolymer. Demontierbare Schirmhalterung aus Technopolymer.

E_Perchero de pie con estructura en acero pintado con polvos epoxídicos. Cabezas en tecnopolímero. Aro paraguero exportable en tecnopolímero

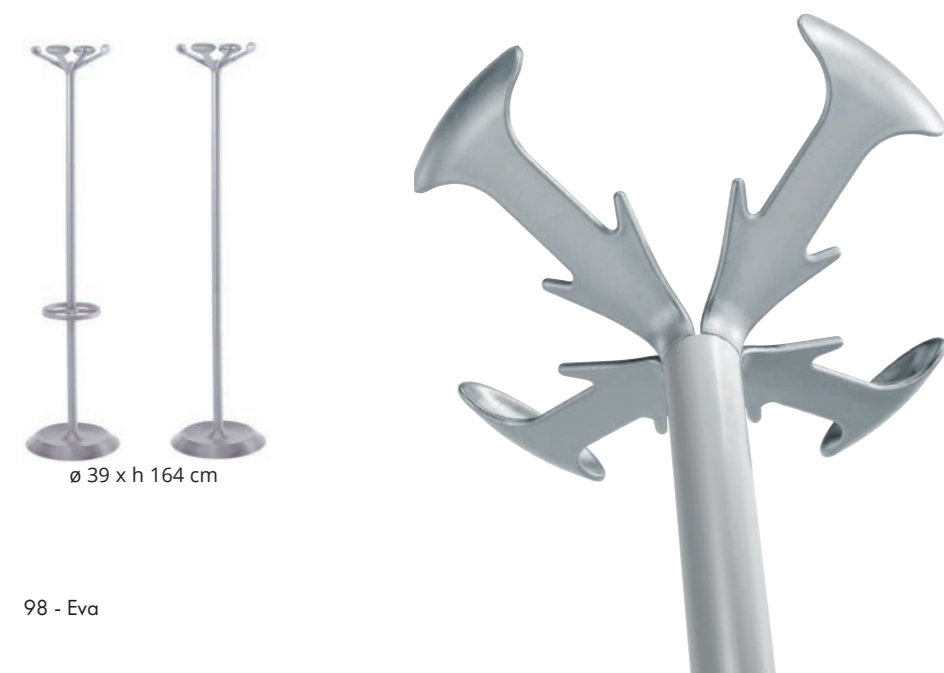

ø 39 x h 164 cm



KING Angelotti & Cardile

I_Portabiti a piantana con struttura in acciaio verniciato con polveri epossidiche. Teste in tecnopolimero. Anello portaombrelli e vaschetta raccogliocce asportabili in tecnopolimero.

EN_Coat stands with stem in epoxy painted steel. Heads in high-tech polymer. Removable umbrella ring and drip tray in high-tech polymer.

F_Portemanteaux avec corps en acier peint en époxy. Têtes en techno-polymère. Anneau porte-parapluies et réceptacle amovibles en techno-polymère.

D_Garderobenständer mit Standsäule aus pulverbeschichtetem Stahl. Kopfteil aus Technopolymer. Demontierbare Schirmhalterung und Abtropftasse aus Technopolymer.

E_Perchero de pie con estructura en acero pintado con polvos epoxídicos. Cabezas en tecnopolímero. Aro paraguero y cubeta recoge aguas exportables en tecnopolímero.



ø 39 x h 172 cm



MAESTRALE

Massimo Colagrande

I_Portabiti realizzato in legno multistrato tinto ebano, con pomoli in metallo tornito color bronzo.

EN_Coat stand in ebony finish plywood, with bronze finish turned metal knobs.

F_Portemanteau réalisé en bois multicouches teinté ébène, avec pommeaux en métal tourné couleur bronze.

D_Garderobenständer aus Schichtholz mit Ebenholzoptik und Knöpfen aus bronzefarbenem gedrehtem Metall.

E_Perchero realizado en madera multicapa teñida color ebano, con pomelos de metal torneado color bronce.



ø 55 x h 161 cm

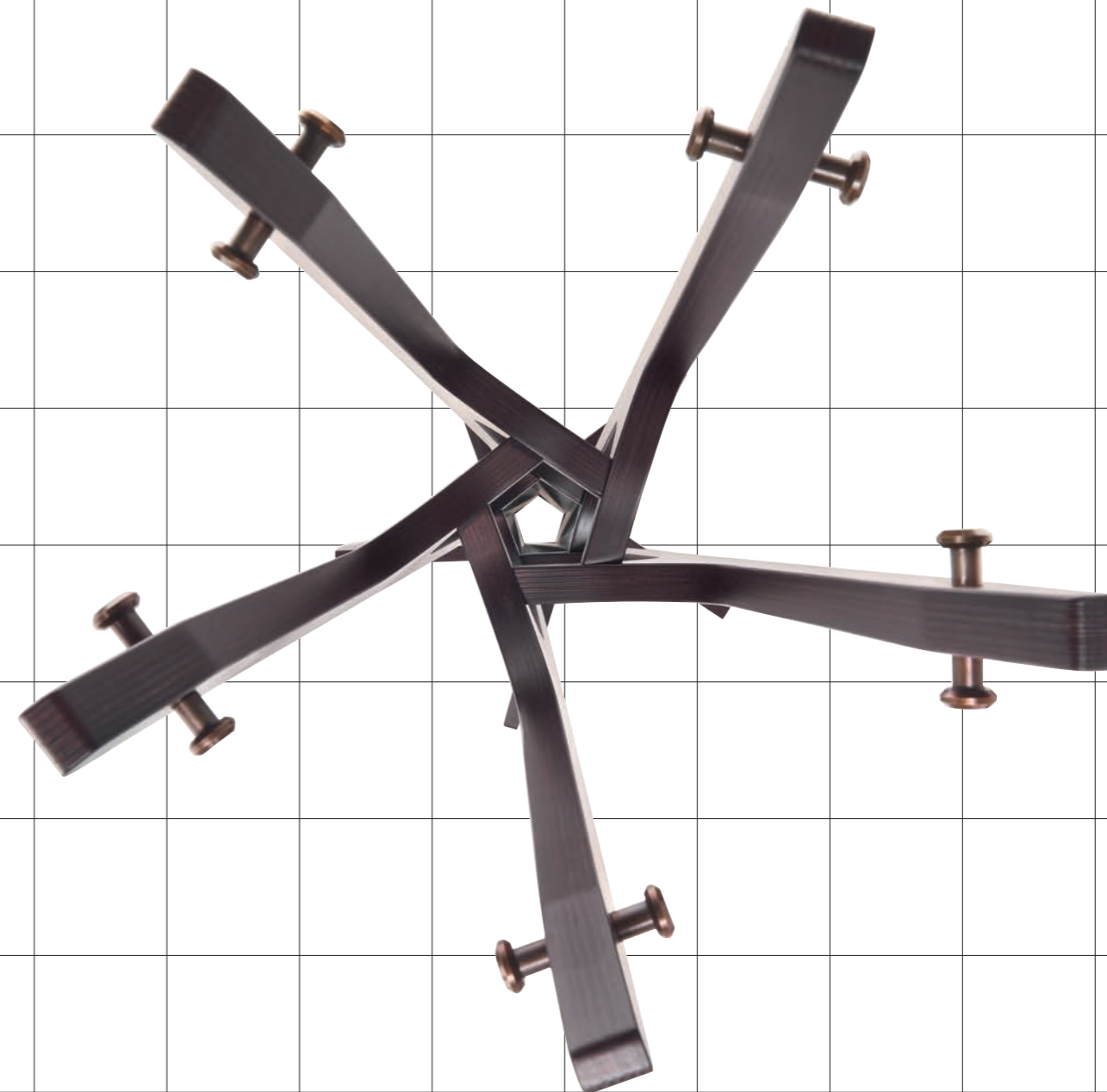

BATTISTA Color

Michele De Lucchi con Sezgin Aksu

I Portabiti con testa in alluminio pressofuso verniciato con polveri epossidiche, tubo e base in acciaio verniciato con polveri epossidiche.

EN Coat stand with head made of epoxy powder-coated die-cast aluminum, and with uprights and a base made of epoxy powder-coated steel.

F Porte-vêtements avec tête en aluminium coulé sous pression peint en époxy, tuyau et bases en acier peint en époxy.

D Kleiderständer mit pulverbeschichtetem Aluguss-Kopfelement, Gestell und Fuß aus pulverbeschichtetem Stahl.

E Perchero con cabezal de aluminio fundido pintado con polvos epoxi, tubo y base de acero pintado con polvos epoxi.



ø 30 x h 161 cm





BATTISTA

Michele De Lucchi con Sezgin Aksu

I_I portabiti e i portaombrelli Battista sono realizzati in alluminio pressofuso e acciaio verniciato con polveri epossidiche, mentre le basi sono in ghisa verniciata con polveri epossidiche o in acciaio inox.

EN_The Battista coat stand and umbrella stand are in die-cast aluminum and epoxy powder-coated steel, while the bases are in epoxy powder-coated cast iron or stainless steel.

F_Les portemanteaux et porte-parapluies Battista sont en aluminium moulé sous pression et acier peint en époxy, tandis que les bases sont en fonte peinte en époxy ou en acier inox.

D_Die Garderobe- bzw. Schirmständer Battista aus Aluminiumguss und pulverbeschichtetem Stahl verfügen über Standfüße aus pulverbeschichtetem Gusseisen oder aus Edelstahl.

E_Los percheros y paragueros Battista son de aluminio fundido y acero pintado con polvos epoxi. Las bases están realizadas en fundición gris recubierta con pinturas epoxi o son de acero inox.

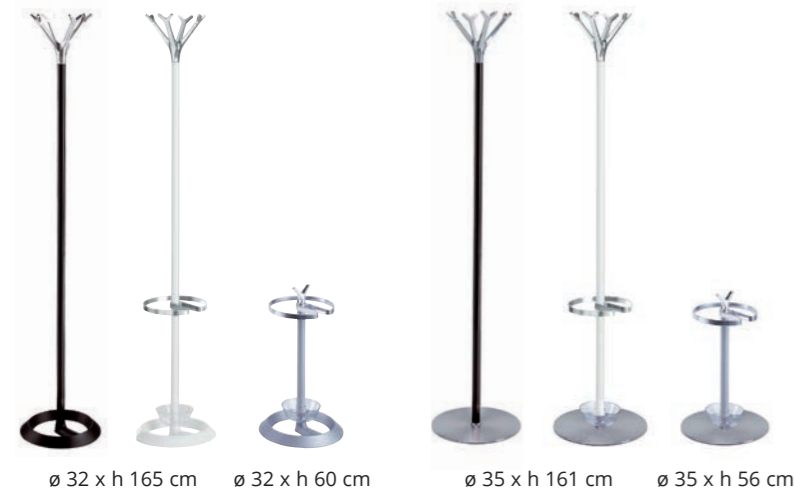



BATTISTA Hook

Michele De Lucchi con Sezgin Aksu

I_Portabiti da parete in alluminio lucidato

EN_Polished aluminum wall hanger.

F_Portemanteau mural en aluminium poli.

D_Garderobehaken aus poliertem Aluminium.

E_Perchas de pared en aluminio pulido.

9 x 8 x h 15 cm



HOO

Raffaello Manzoni

I_Portabiti a parete modulare in acciaio cromato con ganci in tecnopolimero.

EN_Chrome-plated modular wall-mounted coat rail with high-tech polymer hooks.

F_Portemanteau mural modulaire en acier chromé avec crochets en technopolymère.

D_Modulare Wandgarderobe mit Haken aus Technopolymer.

E_Percheros de pared modular en acero cromado con ganchos en tecnopolimero.

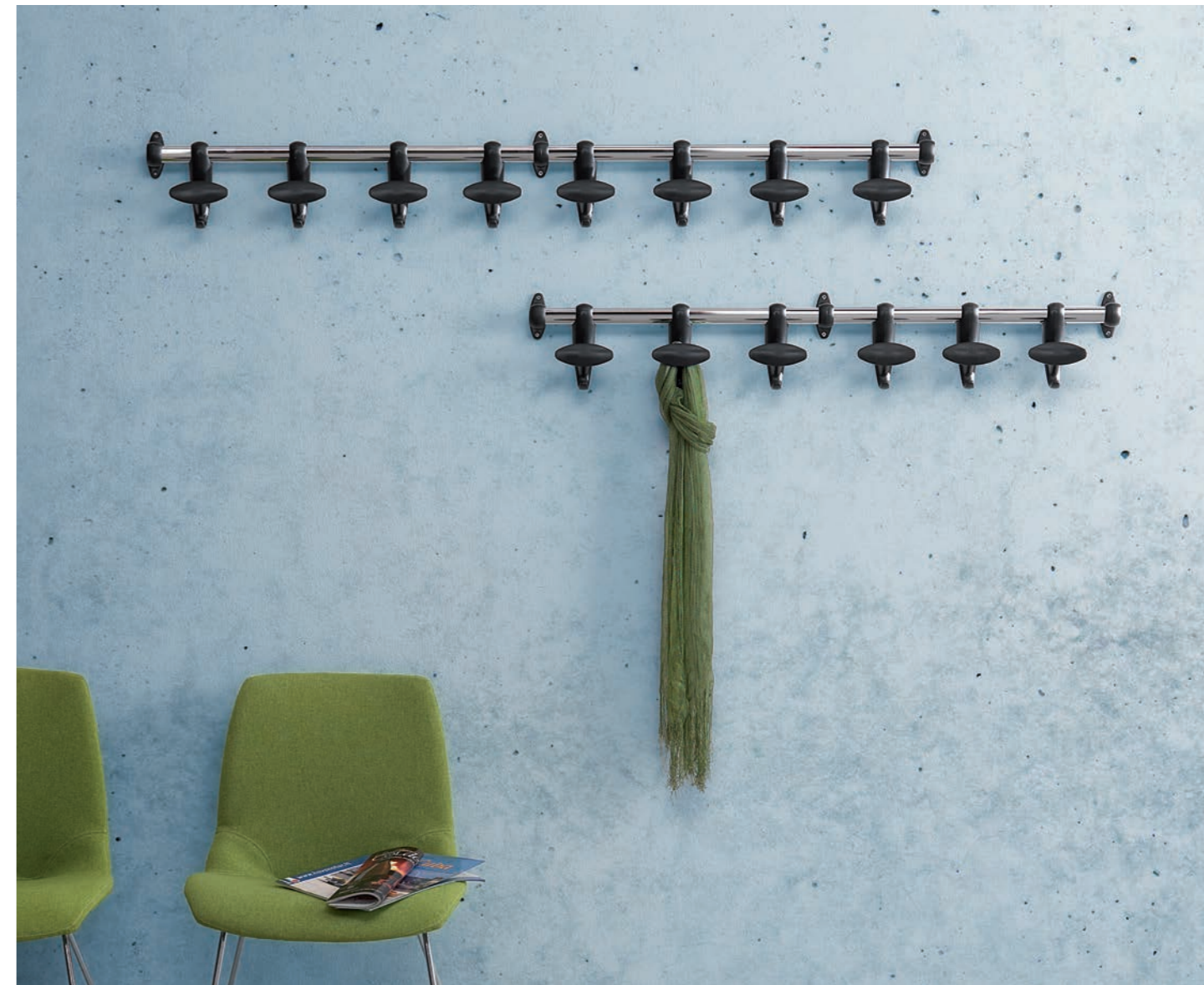
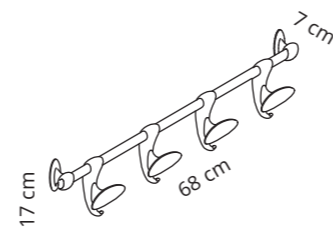
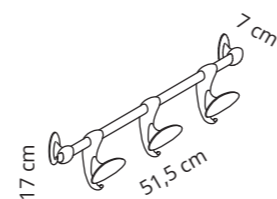
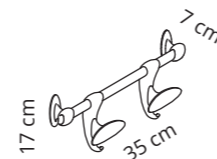

DUO

Angelotti & Cardile

I_Portabiti a parete modulare in tecnopolimero.

EN_High-tech polymer modular wall-mounted coat rail.

F_Portemanteau mural modulaire en technopolymère.

D_Wandgarderobe aus Technopolymer.

E_Perchero de pared modular en tecnopolímero.

30 x 6 x h 12,5 cm

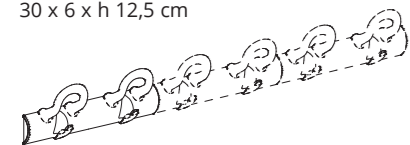

AMBROGIO / AMBROGINO

Angelotti & Cardile

I_Sistemi componibili di portabiti a parete realizzati in alluminio lucido e acciaio cromato.

EN_Systems of wall-mounted coat rails in polished aluminum and chrome-plated steel.

F_Systèmes modulaires de portemanteaux muraux en aluminium poli et acier chromé.

D_Modulares Wandgarderobesystem aus glänzendem Aluminium und verchromtem Stahl.

E_Sistemas componibles de perchas de pared en aluminio brillante y acero cromado.

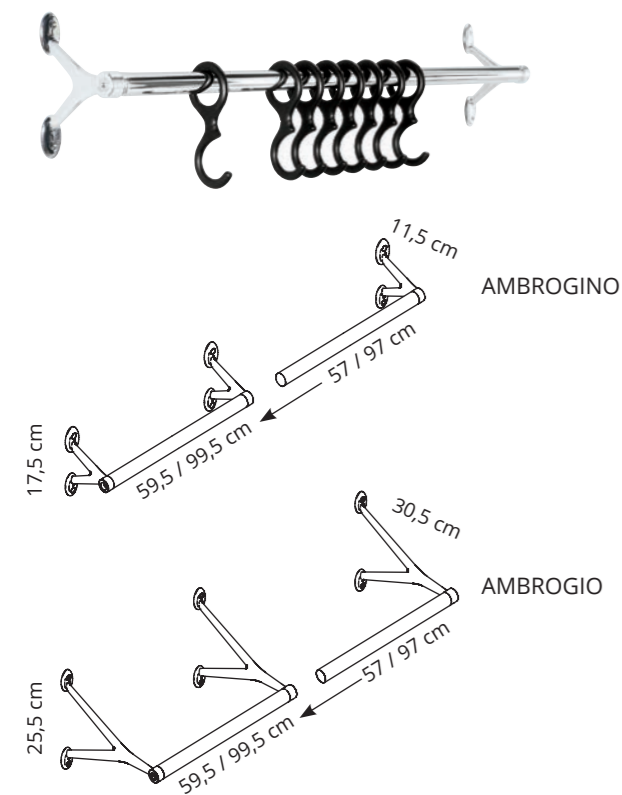

OMETTO / HANGER

Angelotti & Cardile / Claus Breinholt

I_Grucce appendiabiti in tecnopolimero.

EN_High-tech polymer coat hangers.

F_Cintres pour vêtements en technopolymère.

D_Kleiderbügel aus Technopolymer.

E_Perchas para ropa en tecnopolímero.



41,5 cm



7 cm

OMETTO



42 cm

HANGER

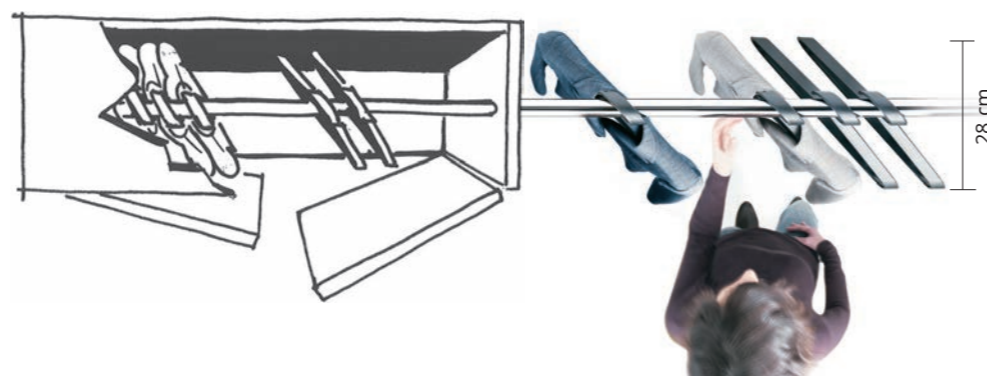

28 cm



RAPID Caimi Lab

I_Stander con struttura in acciaio verniciato con polveri epossidiche, barra portabiti in acciaio cromato, dotato di ruote in tecnopolimero. I montanti proseguono brevemente oltre l'altezza del tubo appendiabiti in modo da contenere lateralmente le grucce portabiti.

EN_A coat stand with an epoxy powder coated steel frame, chromed steel clothes rail and technopolymer wheels. The uprights extend slightly above the height of the clothes rail to hold the hangers on the sides.

F_Portant à vêtements à cadre en acier peint en époxy avec tringle en acier chromé, équipé de roulettes en techno polymère. Les deux montants dépassent un peu la tringle afin de maintenir les cintres.

D_Reihengarderobe mit Epoxidpulver-Beschichtung, Kleiderstange aus verchromtem Stahl, Rollen aus Technopolymer. Die senkrechten Aufbauteile enden über der Kleiderstange und bieten so eine seitliche Begrenzung für die Kleiderbügel.

E_Perchero de barra que presenta una estructura de acero barnizado con polvos epoxi, con barra para colgar en acero cromado y ruedas realizadas en tecnopolímero. Los montantes verticales superan levemente la altura de la barra, de manera que sujetan lateralmente las perchas.



146 x 50 x h 170 cm



86 x 50 x h 170 cm

SPEECH Stander Angelotti & Cardile

I_Stander portabiti realizzato in acciaio cromato e caratterizzato dalla base in alluminio lucidato montata su ruote con freno.

EN_A mobile clothes stand made of chrome-plated steel tubes fixed to a polished aluminum base with lockable casters.

F_Portemanteau sur roulettes en acier chromé caractérisée par sa base en aluminium poli montée sur des roues avec frein.

D_Kleiderständer aus Chromstahl mit einem polierten Aluminiumfuss auf Rollen und mit Bremse.

E_Perchero Stander de acero cromado que se compone de una base de aluminio brillante montada sobre ruedas con freno.



123 x 60 x h 180 cm

SWING

Claudio Bellini

I_Cestino gettacarte realizzato in tecnopolimero lucido.

EN_Waste paper basket carried out in glossy high-tech polymer.

F_Corbeille à papier réalisée en technopolymère brillant.

D_Papierkörbe aus glänzendem Technopolymer.

E_Papelera de tecnopolímero brillante.



25 x 25 x h 32 cm



HI-TECH Caimi Lab

I_Cestini gettacarte in polipropilene.

EN_Waste paper baskets in polypropylene.

F_Corbeilles à papier en polypropylène.

D_Papierkörbe aus Polypropylen.

E_Papeleras de polipropilene.



ø 28 x h 35 cm



DIVIDO

Caimi Lab

I_Cestino per la raccolta differenziata interamente realizzato in tecnopolimero. Il cestino è fornito di serie con un divisorio interno e relativo fermasacchetto superiore liberamente posizionabili ad incastro permettendo di ottenere vani con la capienza desiderata.

EN_Bin for recycling made entirely of technopolymer. It comes with an internal partition and accompanying bag holder at the top, both of which can be freely positioned allowing for compartments with the desired capacity.

F_Corbeille pour le tri des déchets entièrement réalisée en technopolymère. La corbeille est dotée, de série, d'un séparateur interne avec support de sac supérieur, encastrables dans différentes positions pour obtenir des compartiments de la contenance souhaitée.

D_Abfallbehälter zur Mülltrennung, komplett aus Technopolymer. Der Eimer wird serienmäßig mit einer internen Trennwand und entsprechender Müllbeutel-Halterung an der Oberseite geliefert. Diese sind anhand von Klemm-Mechanismen frei positionierbar, so dass die Behälter das gewünschte Fassungsvermögen erhalten.

E_Cesto completamente de tecnopolímero para la separación de residuos. Se suministra con un divisorio interno y la correspondiente sujeción superior de serie. Estos pueden encajarse libremente, pudiendo así obtener los espacios con la capacidad necesaria.



44,5 x 22 x h 31 cm



DESIGN COLLECTION

Caimi Lab

I_Gettacarte e portaombrelli realizzati interamente in acciaio verniciato con polveri epossidiche.

EN_Powder-coated steel wastepaper baskets and umbrella stands.

F_Corbeilles à papier et porte-parapluies réalisés en acier peint en époxy.

D_Papierkörbe und Schirmständer aus mit Epoxypulver beschichtetem Stahl.

E_Papeleras y paragüeros realizados en acero pintado con polvos epoxídicos.

20 x 20 x h 32 / 50 cm
35 x 20 x h 50 cm





HI-TECH Caimi Lab

I_Cestini gettacarte e portaombrelli realizzati in acciaio verniciato con polveri epossidiche. Anello superiore e base in tecnopolimero.

EN_Powder-coated steel wastepaper baskets and umbrella stands. Upper ring and base in high-tech polymer.

F_Corbeilles à papier et porte-parapluies réalisés en acier peint en époxy. Anneau supérieur et base en techno-polymère.

D_Papierkörbe und Schirmständer aus pulverbeschichtetem Stahl. Boden und Oberkante aus Technopolymer.

E_Papeleras y paragüeros realizados en acero pintado con polvos epoxídicos. Aro superior y base en tecnopolímero.



ø 25 x h 32 cm

ø 25 x h 50 cm



PIOGGIA

Caimi Lab

I_Portaombrelli a rastrelliera realizzato in acciaio verniciato con polveri epossidiche, le vaschette raccogli acqua possono essere posizionate a due altezze per contenere sia ombrelli normali che ombrelli pieghevoli. Le due ruote in tecnopolimero facilitano le operazioni di trasporto.

EN_Umbrella-rack in epoxy-painted steel, the drip trays can be fixed at two heights for both ordinary and folding umbrellas. The two castors in high-tech polymer make the moving easier.

F_Porte-parapluies à râtelier en acier peint époxy, les réceptacles peuvent être positionnés à deux hauteurs pour contenir les parapluies normaux comme pliables. Les deux roulettes en technopolymère facilitent le déplacement.

D_Schirmständer-Gestell aus mit Epoxidpulver beschichtetem Stahl, die Abtropfwannen können auf zwei Höhen verstellt werden, für sowohl normale Schirme als auch für Klappschirme. Die zwei Räder aus Technopolymer erleichtern den Transport.

E_Paragüero con soportes de acero pintado con polvo epoxi, los recogeaguas pueden colocarse en dos alturas diferentes para contener tanto los paraguas clásicos como los plegables. Las dos ruedas de tecnopolímero facilitan las operaciones de transporte.

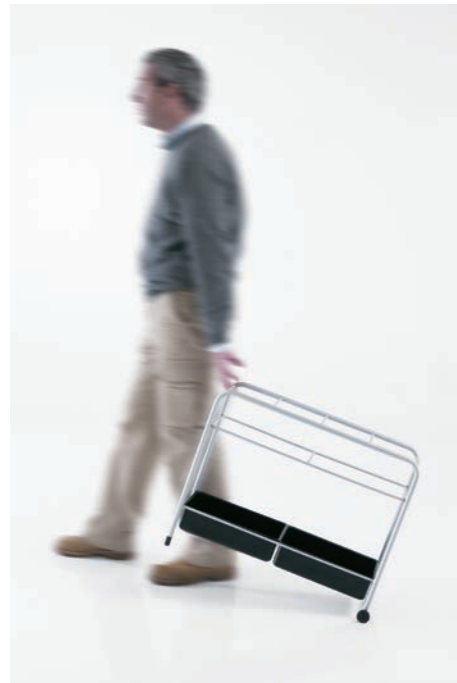
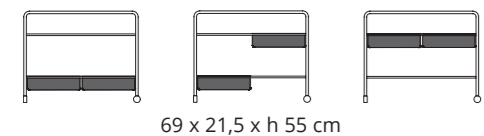

SET

Caimi Lab

I_Colonnina portaborse in acciaio inossidabile satinato, base in acciaio con rivestimento superiore in acciaio inossidabile satinato o verniciato con polveri epossidiche nero gofrato. Utilizzabile come pratico portaborse e come porta buste per ombrelli.

EN_A bag holder consisting of a stanchion made of brushed stainless steel set on a steel base overlaid with satin-finished stainless steel or black embossed epoxy powder-coated steel. It can be used as a practical bag holder or as a wet umbrella bag holder.

F_Colonne porte-sac en acier inoxydable satiné, base en acier avec revêtement supérieur en acier inoxydable satiné ou peint en époxy noir gaufré. A utiliser comme pratique porte-sac ou comme porte-sachets pour parapluies.

D_Mattierter Edelstahlhalter für Taschen, Stahlfuß mit Überguss aus mattiertem Edelstahl oder geprägt und mit schwarzer Epoxidstaublackierung. Kann als praktische Ablage für Taschen und Tüten oder für Regenschirmhüllen verwendet werden.

E_Poste para colgar bolsas realizado en acero inoxidable satinado, con base de acero con acabado superior de acero inoxidable satinado o pintado con polvos epoxi en color negro gofrado. Muy práctico para colgar bolsas o fundas para paraguas.



KABO

Alessandro Zambelli

I_Originale portaombrelli realizzato in gres colorato, ottenuto con una particolare lavorazione a colatura.

EN_An original looking umbrella stand made of colored stoneware, obtained by means of a special casting process.

F_Porte-parapluie original en grès coloré, obtenu à partir d'un moulage particulier.

D_Originelle Schirmablage aus farbigem Steingut, durch ein besonderes Gießverfahren hergestellt.

E_Paragüero original de gres de colores, realizado con un proceso especial de encolado.



EXTERNO

Angelotti & Cardile

I_Posacenere per esterni con fusto in alluminio verniciato con polveri epossidiche. Base in acciaio zincato e verniciato.

EN_Outdoor ashtray with drum in powder-coated aluminum. Base in zinc-coated, painted steel.

F_Cendrier pour extérieur avec fût en aluminium peint époxy. Base en acier zingué et peint.

D_Aschenbecher für draußen mit Standsäule aus mit Epoxidpulver beschichtetem Aluminium, Basis aus verzinktem und beschichtetem Stahl.

E_Ceniceros para exterior con columna de aluminio pintado con polvo epoxi. Base de acero zincado y pintado.

ø 32 x h 100 cm

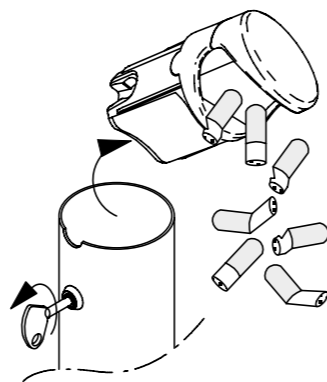

PIAZZA

Caimi Lab

I_Posacenere da parete utilizzabile anche per esterni, realizzato in acciaio inossidabile AISI 304 con vaschetta interna raccogli cenere estraibile, dotato di serratura di sicurezza.

EN_Wall-mounted ashtray also for outdoor use, made from AISI 304 stainless steel, with internal extractable ash box, with safety lock.

F_Cendrier mural utilisable aussi à l'extérieur, réalisé en acier inoxydable AISI 304 avec bac récepteur interne extractible pour les cendres et équipé d'une serrure de sécurité.

D_Wand-Aschenbecher, kann auch in Außenbereichen verwendet werden, hergestellt aus rostfreiem Stahl AISI 304 mit herausnehmbarem Aschenbehälter, versehen mit Sicherheitsverschluss.

E_Cenicero de pared utilizable también para exterior, realizado en acero inoxidable AISI 304 con recipiente interior de recogida de cenizas extraíble, dotado de cerradura de seguridad.

15 x 8 x h 26 cm



SMILE

Caimi Lab

I_Cestino gettacarte da parete utilizzabile anche per esterni, realizzato in acciaio inossidabile AISI 304 con fondo forato per fare defluire l'acqua piovana, dotato di serratura di sicurezza.

EN_Wall-mounted waste-paper basket also for outdoor use, made of AISI 304 stainless steel with perforated bottom for the outflow of rainwater. Equipped with safety lock.

F_Corbeille à papier murale utilisable aussi à l'extérieur, réalisée en acier inoxydable AISI 304, avec fond perforé pour l'écoulement de l'eau de pluie et pourvue de serrure de sûreté.

D_Papierkorb für Wandmontage aus rostfreiem Stahl AISI 304, auch für Aussenanwendung geeignet, mit gelochtem Boden, damit das Regenwasser durchfließen kann, mit Sicherheitsschloss ausgestattet.

E_Papelera a pared para exterior, realizada en acero inoxidable AISI 304 con fondo perforado para evacuar el agua de lluvia. Equipado con cerradura de seguridad.

25 x 13 x h 35 cm



DESK-UP

Acropoli, Caimi Lab

I_Accessori per scrivania e sospesi in tecnopolimero o policarbonato. Profili a parete in alluminio anodizzato.

EN_Desk or suspended accessories in high-tech polymer or polycarbonate. Wall toolbars in anodized aluminum.

F_Accessoires de bureau ou suspendus en technopolymère ou polycarbonate. Profils murales en aluminium anodisé.

D_Schreibtischzubehör zum Aufstellen bzw. Einhängen aus Technopolymer oder Polycarbonat. Wandprofile aus eloxiertem Aluminium.

E_Accesorios para escritorio y suspendidos de tecnopolímero o policarbonato. Perfiles a pared de aluminio anodizado.



BISS

Giulio Iacchetti

I_Passacavi modulare in tecnopolimero con staffa di aggancio utilizzabile sia sotto al piano della scrivania sia sul fianco e peso terminale completamente arrotondato.

EN_Modular high-tech polymer cable sleeve with bracket to fasten under the top or on the side of the desk and a round weight to improve stability.

F_Passe-câbles modulaire en technopolymère avec tige d'accrochage utilisable au-dessous du bureau ou sur le côté, ballast terminal complètement arrondi.

D_Modularer Kabelkanal aus Technopolymer mit Befestigungsleiste, die sowohl unter der Schreibtischplatte als auch seitlich verwendet werden kann, mit beschwertem und abgerundetem Ende.

E_Canaletas pasacables expansible en tecnopolimero con brida de sujeción aplicable bajo la parte inferior del plano del escritorio o en su parte lateral. El peso terminal está completamente redondeado.

L max 79 cm

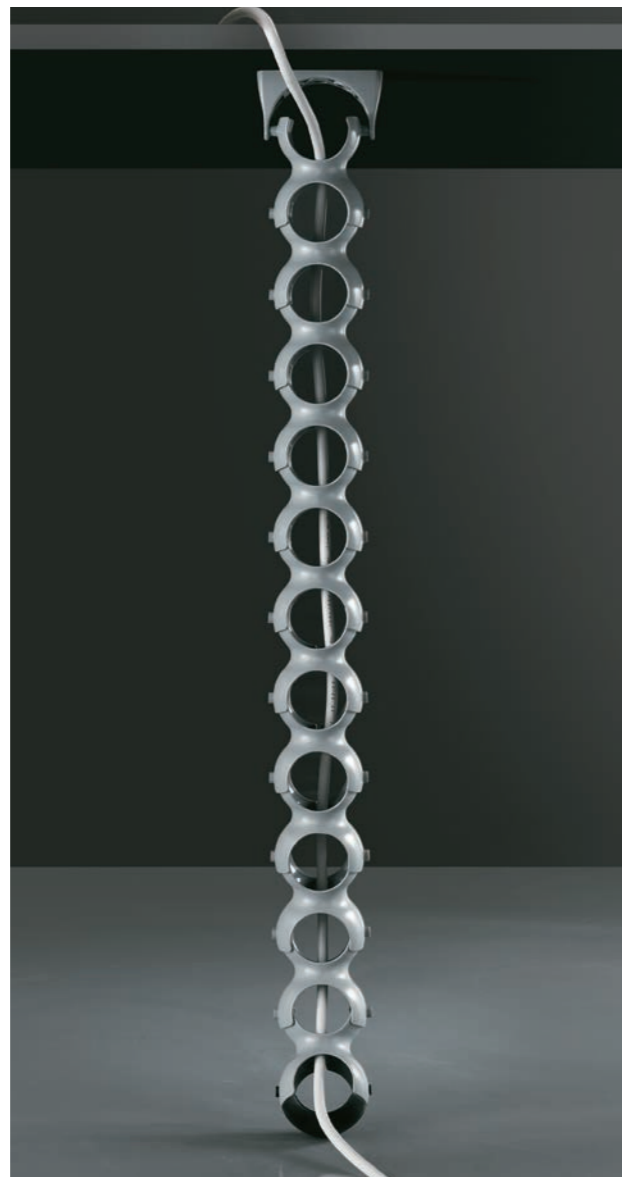

UP

Caimi Lab

I_Ripiano porta-monitor da appoggio su piano della scrivania realizzato in acciaio verniciato con polveri epossidiche.

EN_Monitor shelf to be placed on the desk, carried out in powder-coated steel.

F_Tablette porte-écran à poser sur le plan du bureau, réalisée en acier peint en époxy.

D_Monitorträger aus pulverbeschichtetem Stahl zur Aufstellung auf dem Schreibtisch.

E_Estante para pantallas à posicionar sobre plano de trabajo, realizado de acero pintado epoxi.

33 x 22 x h 10 cm



HI-TECH

Caimi Lab

I_Sottomano in espanso nero.

EN_Desk pad in black plastic foam.

F_Sous-main en expansé noir.

D_Schreibunterlage aus schwarzem Kunststoff.

E_Carpeta en material expandido negro.

50 x 35 cm

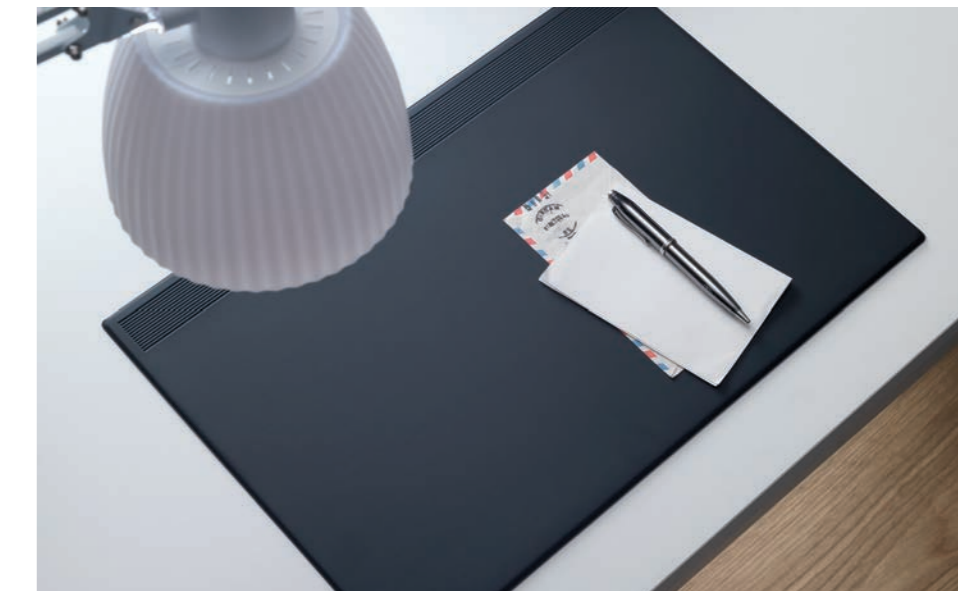

OREDODICI Caimi Lab

I_Orologio da parete in tecnopolimero laccato.

EN_Wall-mounted clock in enamelled high-tech polymer.

F_Horloge mural en technopolymère laqué.

D_Wanduhr aus lackiertem Technopolymer.

E_Reloj de pared de tecnopolímero lacado.



ø 40 cm



ST DORFLES

Gillo Dorfles

IOltre ad essere un acclamato critico d'arte, pittore e filosofo, Gillo Dorfles è stato anche autore di molti libri e saggi. "ST Dorfles" è quindi un tributo alla prolificità culturale e letteraria di Gillo Dorfles; un reggilibro il cui design si rifà ad un suo disegno già parte della collezione "Snowsound Art - Per un Gigantismo del Disegno" di Caimi.

ENIn addition to his acclaimed work as an art critic, painter and philosopher, Gillo Dorfles was the author of numerous books and essays. "ST Dorfles" is a tribute to his cultural and literary legacy—a bookend designed after one of his drawings from Caimi's collection "Snowsound Art - Enormous Design".

FCritique d'art, peintre et philosophe reconnu, Gillo Dorfles a été également l'auteur de nombreux livres et essais. « ST Dorfles » est donc un hommage à la prolificité culturelle et littéraire de Gillo Dorfles ; un serre-livres dont le design s'inspire de l'un de ses dessins appartenant à la collection « Snowsound Art - Per un Gigantismo del Disegno » de Caimi.

DGillo Dorfles war nicht nur ein anerkannter Kunstkritiker, Maler und Philosoph, sondern auch Autor zahlreicher Bücher und Essays. „ST Dorfles“ ist daher eine Hommage an das kulturelle und literarische Vermächtnis von Gillo Dorfles: Eine Buchstütze, deren Design auf einer seiner Zeichnungen basiert, die bereits Teil der Kollektion „Snowsound Art - Per un Gigantismo del Disegno“ von Caimi ist.

EPopularmente conocido en su papel de crítico de arte, pintor y filósofo, Gillo Dorfles también fue autor de numerosos libros y ensayos. "ST Dorfles" constituye un homenaje a la prolífica obra de Gillo Dorfles, tanto en el ámbito cultural como en el literario; un atril que evoca un diseño suyo que ya formaba parte de la colección "Snowsound Art - Per un Gigantismo del Disegno", de Caimi.

30 x 15 x h 20 cm



PLAT

Alessandro Zambelli

I Originale oggetto polifunzionale realizzato in gres colorato: ogni singolo pezzo è ottenuto con una particolare lavorazione manuale di colatura. Utilizzabile come portaoggetti o portapenne.

EN An original looking multifunctional object made of colored stoneware: each single piece is specially cast by hand. It can be used as a recipient for miscellaneous items or as a pen holder..

F Objet original multifonctions réalisé en grès coloré : chaque pièce est obtenue avec un moulage particulier fait à la main. A utiliser comme porte-objet ou porte-stylo.

D Originelles Mehrzweckobjekt aus farbigem Steingut. Jedes Einzelstück wird in einem besonderen manuellen Gießverfahren hergestellt. Kann als Ablage für Material oder Kugelschreiber verwendet werden.

E Objeto original multifuncional de gres de colores: cada pieza está hecha a mano con un proceso especial de encolado. Se puede usar como portaobjetos o portalápices.

34 x 22 x h 7 cm



KABO

Alessandro Zambelli

I Originale oggetto polifunzionale realizzato in gres colorato: ogni singolo pezzo è ottenuto con una particolare lavorazione manuale di colatura. Utilizzabile come portafiori, portaoggetti, portapenne, portaombrelli o, semplicemente, grazie alle forme sinuose, come oggetto decorativo d'arredo.

EN An original looking multifunctional object made of coloured stoneware: each single piece is specially cast by hand. It can be used as a vase, as a recipient for miscellaneous items, as a pen holder, as an umbrella stand or, simply as a decorative piece of sinuously elegant furniture.

F Objet original multifonctions réalisé en grès coloré: chaque pièce est obtenue avec un moulage particulier fait à la main. A utiliser comme porte-fleurs, porte-objets, porte-stylo, porte-parapluies ou, simplement à cause de ses formes sinueuses, comme objet de décoration d'intérieur.

D Originelles Mehrzweckobjekt aus farbigem Steingut: Jedes Einzelstück wird in einem besonderen manuellen Gießverfahren hergestellt. Kann als Blumentopf, Ablage für Material oder Kugelschreiber, Schirmablage oder einfach, dank seiner anmutigen Form, als dekoratives Einrichtungselement verwendet werden.

E Objeto original multifuncional de gres de colores: cada pieza está ensamblada a mano con un proceso especial de encolado. Se puede usar como maceta, portaobjetos, portalápices, paraguero o, simplemente, gracias a su forma sinuosa, como objeto decorativo.

46 x 32 x h 15 cm



Lighting

I Molto più che semplici fonti di luce, questi corpi illuminati portano con sé significati più profondi, legati a particolari funzioni accessorie piuttosto che originali scelte tecniche. Veri esempi di design all'avanguardia che con semplicità interpretano eleganza, personalità e comfort.

EN More than just basic sources of illumination, these lights embody deeper meanings linked to specific accessory functions rather than mere technical choices. They are examples of cutting-edge design, interpreting elegance, personality and comfort with refreshing simplicity.

F Plus que de simples sources de lumière, ces systèmes d'éclairage sont porteurs de significations plus profondes, liées à de particulières fonctions accessoires plutôt qu'à des choix techniques originaux. De véritables exemples de design d'avant-garde qui interprètent avec simplicité l'élégance, la personnalité et le confort.

D Diese Leuchtkörper sind viel mehr als bloße Lichtquellen, ihre tiefere Bedeutung verdanken sie ihren einzigartigen Zusatzfunktionen und origineller technischer Auswahl. Sie sind ein Beispiel für innovatives Design, das in seiner Schlichtheit Eleganz, Persönlichkeit und Komfort vereint.

E Mucho más que una mera fuente de luz, estos objetos luminosos encierran significados más profundos, vinculados a funciones complementarias peculiares y a originales decisiones técnicas. Diversos ejemplos de diseños de vanguardia que interpretan con sencillez la elegancia, la personalidad y el confort.

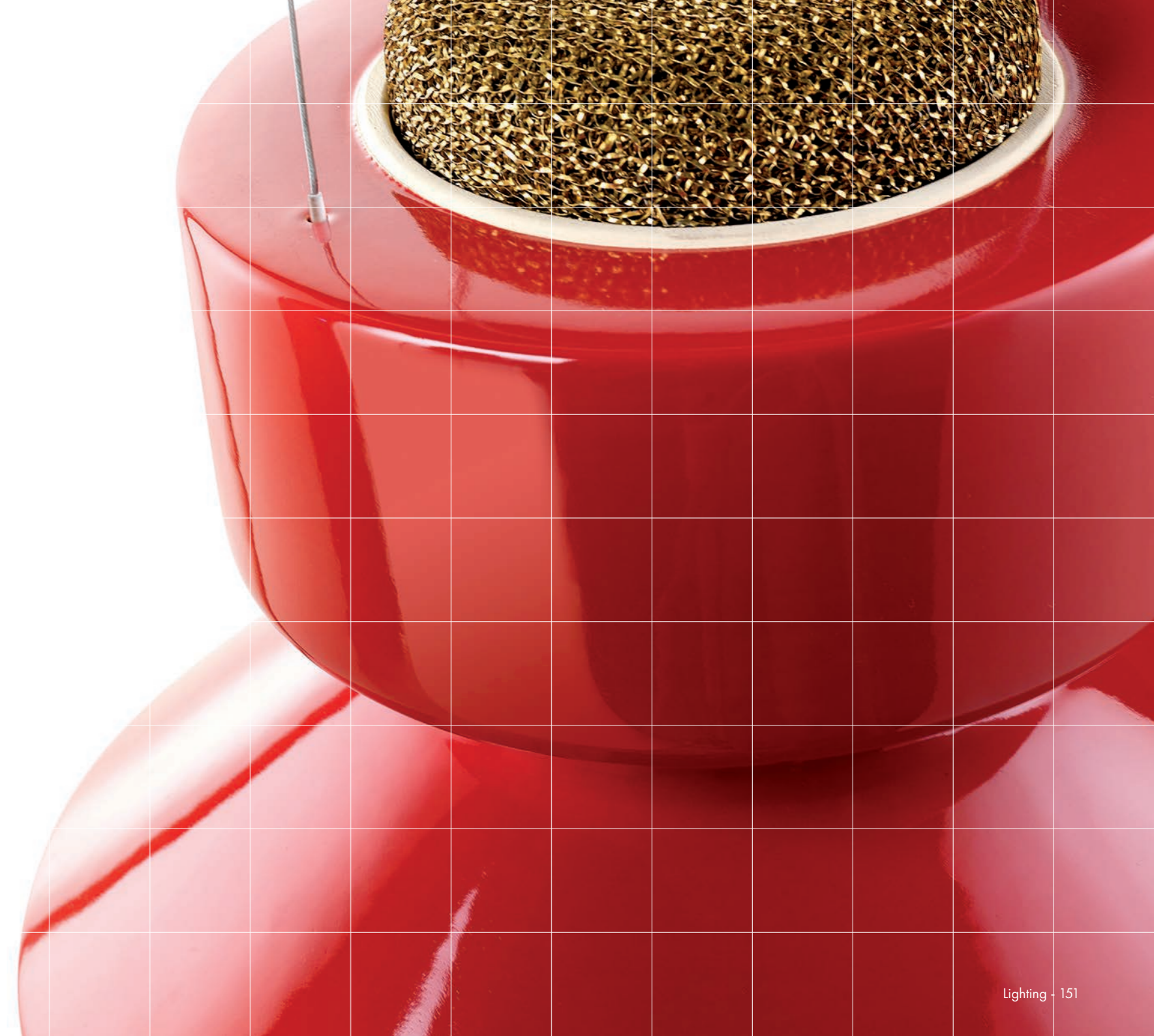

TELETA

Alessandro Zambelli

I Il progetto Teleta nasce con il preciso scopo di riutilizzare l'energia persa in calore delle sorgenti LED migliorandone la sostenibilità energetica, il calore provocato dalle lampadine crea un flusso d'aria ascendente che viene convogliato attraverso un filtro anodizzato con ioni di argento che abbattano la carica batterica in modo significativo. Le lampade sono state testate dal vero presso un laboratorio di analisi microbiologiche per attestare la capacità di abbattimento della carica microbica presente nell'aria.

EN The Teleta project was born with the precise purpose of reusing the energy lost as heat from LED sources, hence improving their energetic sustainability. The heat generated by the LED creates an ascending air flow that is conveyed through an anodized filter with silver ions that lowers the bacterial load significantly. The lamps have been tested in real life in a microbiological analysis laboratory to certify their ability to reduce the microbial load in the air.

F Le projet Teleta est né avec le but précis de réutiliser l'énergie perdue avec la chaleur des lampes LED en améliorant leur durabilité énergétique. La chaleur créée par les lampes donne lieu à un flux d'air ascendant qui est canalisé à travers un filtre anodisé avec des ions d'argent qui réduisent considérablement la charge bactérienne. Les lampes ont été testées en situation réelle dans un laboratoire de tests microbiologiques pour certifier leur capacité de réduction de la charge microbienne dans l'air.

D Das Teleta-Projekt wurde mit dem Ziel ins Leben gerufen, die in Form von Wärme verlorengewonnene Energie von LED-Quellen zurückzugewinnen und so die energetische Nachhaltigkeit zu verbessern. Die Wärme der Glühbirnen erzeugt einen nach oben gerichteten Luftstrom, der durch einen mit Silberionen anodisierten Filter geleitet wird, der die bakterielle Belastung deutlich reduziert. Die Lampen wurden in einem mikrobiologischen Prüflabor unter realen Bedingungen getestet, um ihre Fähigkeit zur Verringerung der mikrobiellen Belastung der Luft nachzuweisen.

E El proyecto Teleta nace con el objetivo de reutilizar la energía calorífica perdida que generan las fuentes LED, mejorando así su sostenibilidad energética. El calor generado por el LED crea un flujo de aire ascendente que se conduce hacia un filtro anodizado con iones de plata que reduce significativamente la carga bacteriana. Las lámparas han sido testadas en un laboratorio de análisis microbiológicos para certificar su capacidad de reducción de la carga microbiana presente en el aire.



AIR PURIFICATION TECHNOLOGY



I Il calore della lampada riscalda l'aria nella parte superiore generando un moto convettivo. L'aria così riscaldata passa attraverso un filtro realizzato in maglia di alluminio, galvanizzato e trattato con ioni d'argento, purificandosi.

EN The lamp heats the air in the upper part, generating a convective motion. The heated air passes through a filter made of galvanized aluminum mesh, treated with silver ions, purifying itself.

F La chaleur d'une lampe réchauffe l'air dans la partie supérieure, en créant un mouvement convectif. Cet air chaud est purifié en passant à travers un filtre en maille d'aluminium galvanisé et traité aux ions d'argent.

D Die Wärme der Lampe erhitzt die Luft im oberen Bereich und erzeugt eine Konvektionsbewegung. Die so erwärmte Luft strömt durch einen Filter aus galvanisiertem Aluminiumgewebe, das mit Silberionen behandelt wurde, und wird so gereinigt.

E La lámpara calienta el aire en la parte superior, generando un movimiento convectivo. El aire caliente pasa a través de un filtro de malla de aluminio galvanizado, tratado con iones de plata, purificándose.

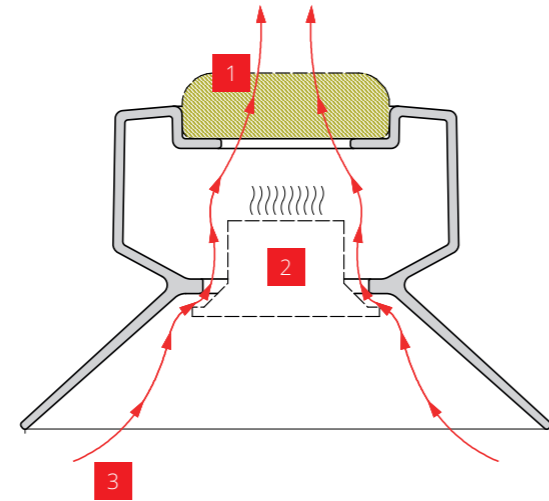

1 **I** Filtro di purificazione dell'aria.
EN Air purification filter.
F Filtre de purification de l'air.
D Luftreinigungsfilter.
E Filtro de purificación del aire.

2 **I** Corpo illuminante LED.
EN LED element.
F Corps d'éclairage à LED.
D LED-Leuchtkörper.
E Cuerpo de iluminación LED.

3 **I** Flusso dell'aria.
EN Air flow.
F Flux d'air.
D Luftstrom.
E Flujo de aire



Clicca e scarica il pdf.
Click and download pdf file.



Guarda il video



Watch the video

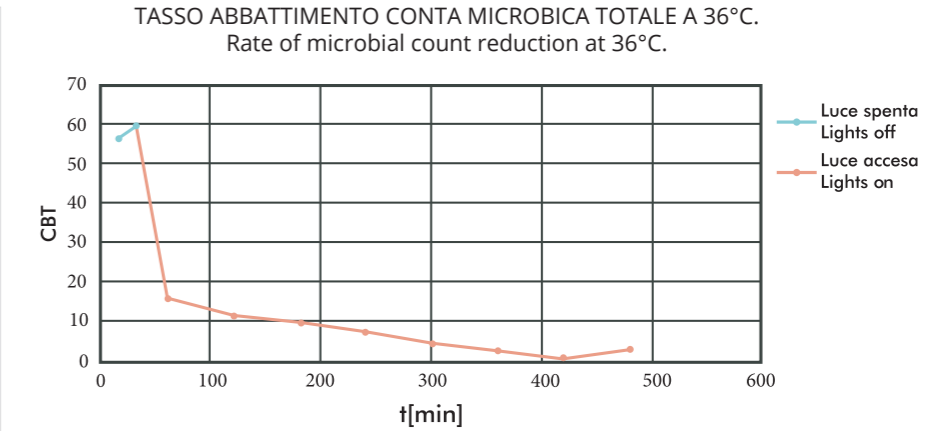

I Conta microbica totale a 36°C con lampada spenta e con lampada accesa.
EN Total microbical count at 36°C with the lamp turned on and off.

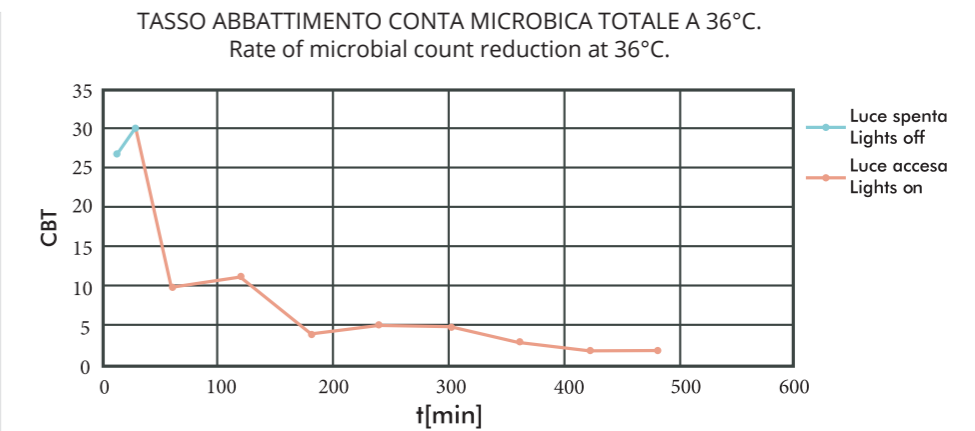

I Conta microbica totale a 36°C con lampada spenta e con lampada accesa.
EN Total microbical count at 36°C with the lamp turned on and off.

OPERA

Francesca Smiraglia

I_Corpi illuminati sferici realizzati in tecnopolimero traslucido. Dotati di cavi regolabili in altezza per la sospensione a soffitto, disponibili in tre diverse dimensioni. La peculiarità di questo oggetto è rappresentata dal disallineamento del cavo di alimentazione rispetto a quello di sospensione che dona una piacevole asimmetria al prodotto.

EN_Spherical lights made of translucent technopolymer. Equipped with height-adjustable cables for suspension from the ceiling, they are available in three different sizes. The uniqueness of this object lies in the deliberate misalignment of the power cable compared to the suspension cable, which gives the light a rather pleasing asymmetry.

F_Lampes sphériques fabriquées en techno polymère translucide. Équipées de câbles réglables pour la suspension au plafond, disponibles en trois différentes tailles. La particularité de cet objet est le désalignement du câble d'alimentation par rapport au câble de suspension, ce qui donne au produit une agréable asymétrie.

D_Kugelförmige Leuchtkörper aus lichtdurchlässigem Technopolymer. Ausgestattet mit in der Höhe verstellbaren Kabeln für die Befestigung an der Decke, erhältlich in drei verschiedenen Längen. Die Besonderheit dieses Objekts besteht darin, dass Stromkabel und Halter versetzt zueinander angebracht werden, was dem Produkt eine gefällige Asymmetrie verleiht.

E_Luminaria colgante de forma esférica realizada en tecnopolímero traslúcido. Dotada de cables de suspensión de altura regulable, disponible en tres dimensiones distintas. La peculiaridad de este objeto radica en el desalineamiento entre el cable de alimentación y el de suspensión, que confiere una agradable asimetría al producto.

∅ 20 / ∅ 30 / ∅ 45 cm





Tables & Seating

I Sedie e tavoli rappresentano una scelta di carattere identificativo all'interno di ogni ambiente: arredi di primaria importanza che devono avere un design ed una qualità riconoscibili. Oggetti iconici, come le sedute Kaleidos, proposte in diversi colori e finiture, dal design essenziale e raffinato, abbinata alle sinuose ed eleganti strutture in alluminio dei tavoli Pegaso, o dei funzionali tavolini Jolly, Cicerone e Susu. Oggetti d'arredo intramontabili grazie all'attenzione al dettaglio che ne caratterizza il progetto e la produzione.

EN The choice of tables and chairs is what gives a room its distinctive character: they are items of primary importance that must be recognizable for their design and quality. The iconic Kaleidos chair, notable for its austere yet refined design, is available in several colours and with different finishes, and is a perfect companion for an elegantly sinuous aluminum Pegaso table, or, equally, for one of the practical and functional Jolly, Cicerone and Susu coffee tables. Thanks to the attention to detail that has gone into their design and production, these items of furnishing never go out of date.

F Le choix des chaises et tables caractérise et identifie chaque intérieur: ce sont des éléments d'ameublement qui possèdent une importance primaire et doivent se distinguer par leur design et leur qualité. Des objets iconiques, comme les sièges Kaleidos, proposés en différentes couleurs et finissages, au design épuré et sophistiqué, associés aux structures sinueuses et élégantes en aluminium des tables Pegaso, ou des tables basses fonctionnelles Jolly, Cicerone et Susu. Des objets d'ameublement intemporels, grâce à l'attention portée aux détails qui en caractérisent la conception et la production.

D Tische und Stühle verleihen einem Raum seinen individuellen Charakter. Als Einrichtungselemente von ersterer Wichtigkeit müssen sie ein erkennbares Design und erkennbare Qualität zur Schau tragen. Sie müssen ikonischen Charakter haben, wie die Stühle Kaleidos, die mit ihrem raffinierten und minimalen Design in unterschiedlichen Farben und Materialausführungen erhältlich sind und hervorragend zu den weichen, eleganten Aluminiumstrukturen der Pegaso-Tische bzw. zu den funktionalen Beistelltischen Jolly, Cicerone und Susu passen. Einrichtungsgegenstände, die dank der Detailpflege bei Entwurf und Herstellung zeitlos werden.

E Las sillas y las mesas otorgan una decoración única a cada ambiente: son elementos fundamentales que deben poder identificarse por su diseño y calidad. Son objetos icónicos, como las sillas Kaleidos, con sus diferentes colores y acabados, un diseño esencial y refinado, que se acoplan a las sinuosas y elegantes estructuras de aluminio de las mesas Pegaso, o a las funcionales mesas Jolly, Cicerone y Susu. Elementos de decoración atemporales gracias a un diseño y una producción centrados en los detalles.

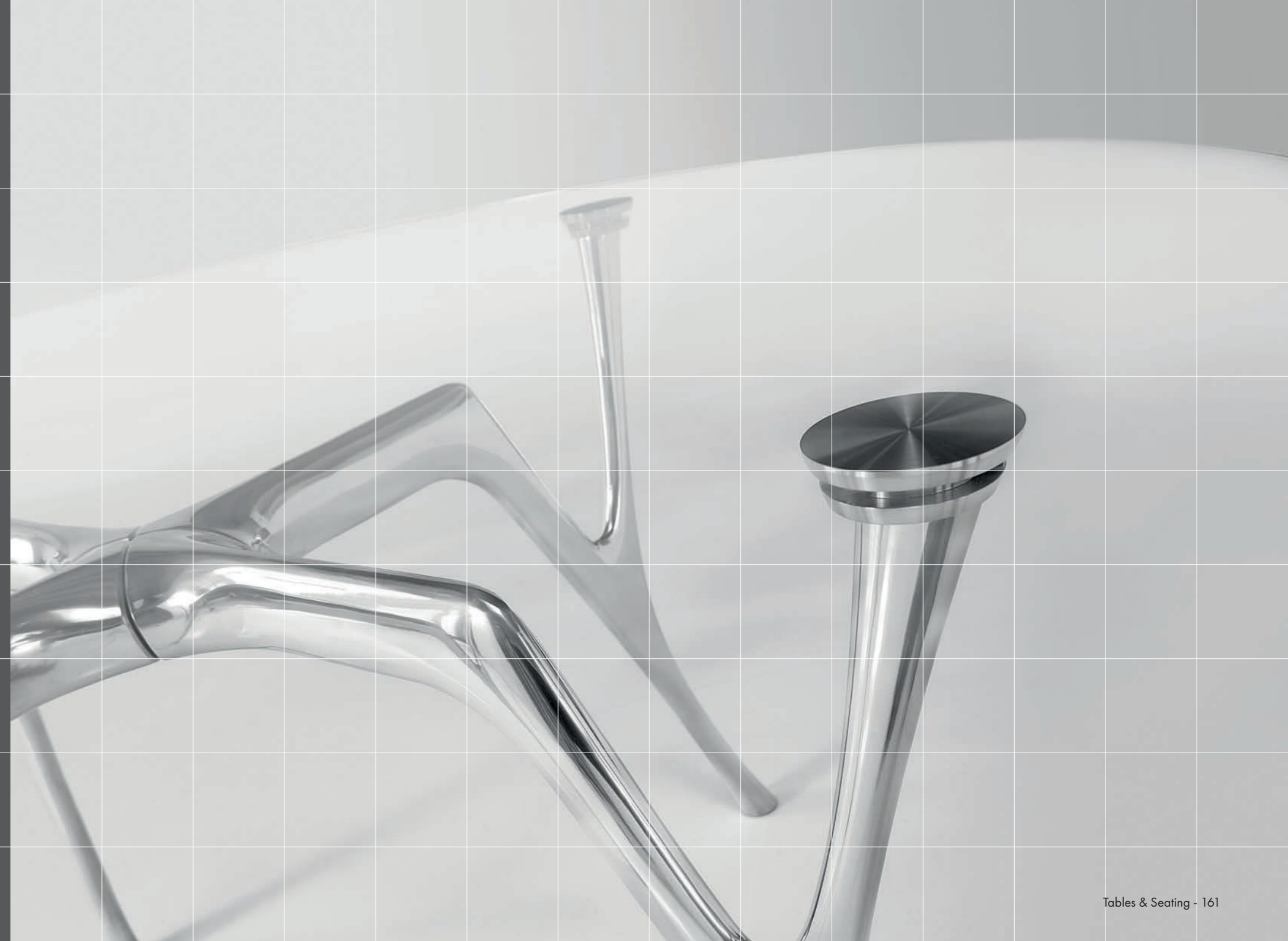

PEGASO Glass

Angelotti & Cardile

I_Tavolo con struttura in alluminio lucido o verniciato, composta da quattro gambe in fusione monoblocco, dotate di piedini regolabili, e da una traversa in tubolare. Piano in vetro temperato e molato trasparente, spessore 12 mm. L'aggancio dei piani alla struttura è realizzato tramite speciali dischi in acciaio inossidabile incollati al piano.

EN_Table with polished or powder-coated aluminum structure formed by four legs in monobloc casting, supplied with adjustable feet, and a tubular crosspiece. Top in tempered and ground glass, transparent, 12 mm thick. The tops are connected to the structure through special discs in stainless steel glued to the top.

F_Table avec corps en aluminium poli ou peint en époxy formée de quatre pieds en fusion monobloc, dotés de pieds réglables et d'une entretoise en tubulaire. Dessus en verre trempé et meulé, transparent, 12 mm d'épaisseur. Le dessus est accroché à la structure au moyen de discs spéciaux en acier inoxydable collés à la surface.

D_Tisch mit Gestell aus poliertem oder pulverbeschichtetem Aluminium, bestehend aus vier Beinen aus einem Gussstück, mit höhenverstellbaren Füßchen und einem Querstab aus Rohreisen. Tischfläche aus gehärtetem und transparent geschliffenem Glas, Dicke 12 mm. Die Verbindung der Platten mit dem Gestell ist aus speziellen rostfreien Stahlscheiben, die auf die Platten geklebt sind.

E_Mesa con estructura de aluminio pulido o pintado con polvos epoxi, formada por cuatro patas de fusión monobloque, dotadas de apoyos regulables y un travesaño de tubo. Superficie de vidrio templado y pulido transparente, espesor 12 mm. Las superficies se enganchan a la estructura mediante discos especiales de acero inoxidable que van pegados a la superficie.





PEGASO Infinito

Angelotti & Cardile

I_Tavolo componibile in lunghezza con struttura in alluminio e piano in vetro temperato e molato trasparente. L'aggancio dei piani alla struttura è realizzato tramite speciali dischi in acciaio inossidabile incollati al piano.

EN_Modular table in length with aluminum structure and top in tempered, ground glass, transparent. The top is linked to the structure through special disks in stainless steel glued to the top.

F_Table modulaire avec structure en aluminium et dessus en verre trempé et biseauté transparent. L'accrochement des plans à la structure est réalisé au moyen de disques spéciaux en inox collés au plan.

D_Modulares Tischsystem mit Untergestell aus Aluminium und Tischplatte aus gehärtetem und geschliffenem Glas, transparent. Die Befestigung der Tischplatte am Gestell erfolgt mit speziellen Scheiben aus Edelstahl, die an die Fläche geklebt werden.

E_Mesa con estructura de aluminio y superficie de vidrio templado y pulido transparente. El enganche de las superficies a la estructura se realiza mediante discos especiales de acero inoxidable que están pegados a la superficie.

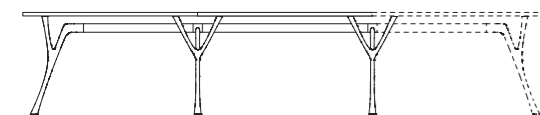



PEGASO Metal / Cemento

Angelotti & Cardile

I Design rigoroso per il tavolo Pegaso, studiato per raggiungere anche dimensioni importanti e proposto con piano in composito estremamente leggero con struttura a "sandwich" costituito da un'anima in legno listellare, racchiuso tra due lastre di alluminio rivestite nella parte superiore e sui bordi perimetrali in cemento o in resina metallica finitura bronzo fuso, in cui il carattere artigianale della lavorazione rende ogni pezzo unico ed esclusivo. Alla semplicità e pulizia formale del piano si contrappongono le forme sinuose della struttura, realizzata in alluminio lucido o verniciato con polveri epossidiche.

EN The Pegaso table has been rigorously designed to allow it to be produced in significant sizes. It features an exceptionally lightweight composite tabletop with a "sandwich" structure, consisting of a blockboard core between two aluminium panels. The top and edges of these panels are finished in concrete or a metallic resin with a cast bronze finish, such that the handcrafted character makes each piece unique and exclusive. The simplicity and formal clarity of the top contrasts with the sinuous shapes of the supporting structure in polished or epoxy powder-coated aluminium.

F Pegaso est une table au design rigoureux, conçue pour être déclinée également en grandes dimensions ; elle est proposée avec un plateau en matériau composite extrêmement léger avec une structure en « sandwich » formée par un cœur en bois latté, contenu entre deux feuilles en aluminium, recouvertes sur la partie supérieure et sur les bords en ciment ou en résine métallique finissage en bronze fondu, dont le caractère artisanal de la fabrication rend chaque pièce unique et exclusive. La simplicité et la netteté formelle du plateau font un beau contraste avec les formes sinueuses de la structure, fabriquée en aluminium poli ou peint à la peinture époxy.

D Ein rigoroses Design für den Tisch Pegaso, der dazu konzipiert ist, auch für große Dimensionen anzunehmen. Seine extrem leichte Verbundplatte mit „Sandwich“-Struktur besteht aus einer Mittellage aus Holz zwischen zwei Aluminiumplatten, die an der Oberseite und an den Umfangskanten mit Zement oder Metallharz mit Bronzeguss-Finish überzogen sind, wodurch die handwerkliche Einzigartigkeit jedes exklusiven Stücks voll zur Geltung kommt. Die Schlichtheit und formale Nüchternheit der Tischplatte steht im Kontrast zu den geschwungenen Formen des Gestells aus Aluminium, glänzend oder mit Epoxidpulver-Beschichtung.

E La mesa Pegaso se caracteriza por un diseño riguroso, estudiado para alcanzar dimensiones significativas, que se propone con un tablero en madera compuesta extremadamente ligero gracias a la estructura de tipo "sandwich", formada por madera listonada recubierta a ambos lados por placas de aluminio revestidas en la parte superior y bordes perimetrales en cemento o resina metálica con acabado en bronce fundido, cuya elaboración artesanal aporta un carácter único y exclusivo a cada pieza. Las líneas limpias y sencillas del tablero contrastan con las formas sinuosas de la estructura, elaborada en aluminio brillante o barnizado con polvo epoxi.

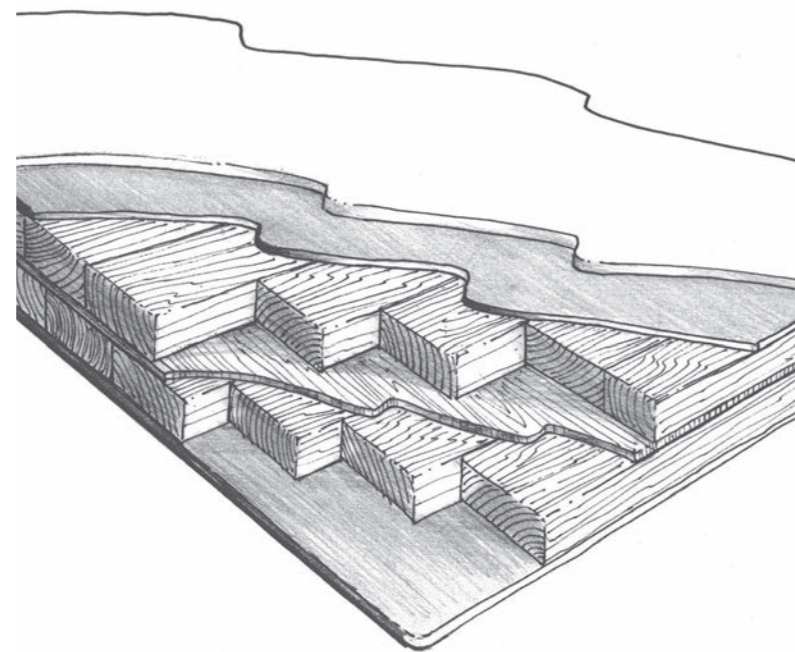

Watch the top
manufacturing
process





PEGASO Metal
Angelotti & Cardile



PEGASO Cemento
Angelotti & Cardile



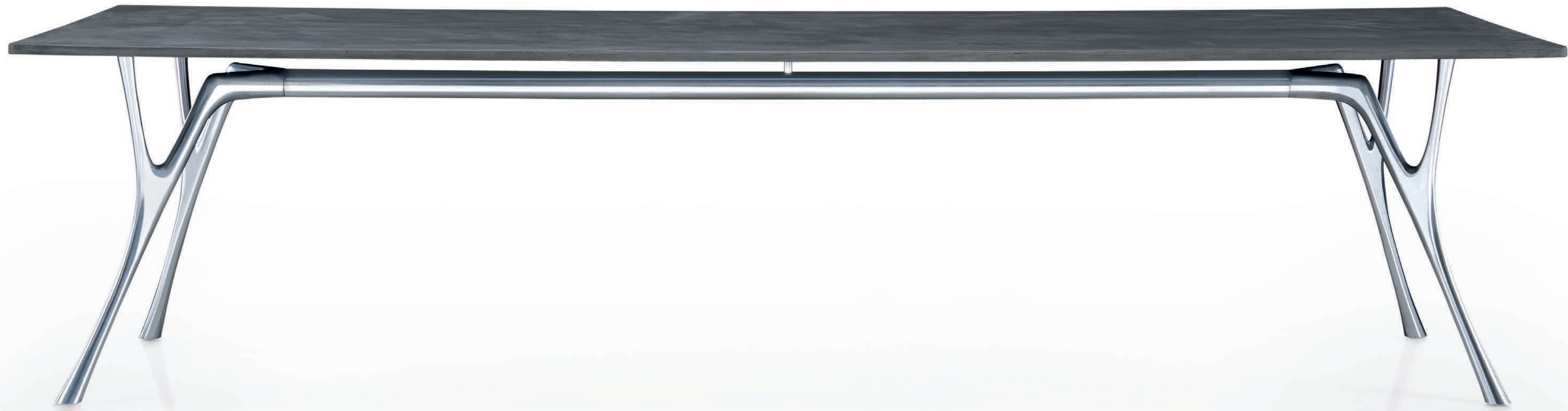

PEGASO Wood / Solid

Angelotti & Cardile

I_Design rigoroso per il tavolo Pegaso, studiato per raggiungere anche dimensioni importanti e proposto con piano in composito estremamente leggero con struttura a "sandwich" costituito da un'anima in legno listellare, racchiuso tra due lastre di alluminio rivestite nella parte superiore e sui bordi perimetrali con un foglio di resina acrilica bianca spazzolata oppure impiallaciato rovere chiaro, rovere nero o noce canaletto. Alla semplicità e pulizia formale del piano si contrappongono le forme sinuose della struttura, realizzata in alluminio lucido o verniciato con polveri epossidiche.

EN_The Pegaso table has been rigorously designed to allow it to be produced in significant sizes. It features an exceptionally lightweight composite tabletop with a "sandwich" structure, consisting of a blockboard core between two aluminium panels. The top and edges of these panels are finished in brushed white acrylic resin or veneered in light oak, black oak or American walnut. The simplicity and formal clarity of the top contrasts with the sinuous shapes of the supporting structure in polished or epoxy powder-coated aluminium.

F_Pegaso est une table au design rigoureux, conçue pour être déclinée également en grandes dimensions ; elle est proposée avec un plateau en matériau composite extrêmement léger avec une structure en « sandwich » formée par un cœur en bois aggloméré, contenu entre deux feuilles en aluminium recouvertes sur la partie supérieure et sur les bords d'une feuille en résine acrylique blanche brossée ou plaquée en chêne clair, en chêne noir ou en noyer canaletto. La simplicité et la netteté formelle du plateau font un beau contraste avec les formes sinueuses de la structure, fabriquée en aluminium poli ou peint à la peinture époxy.

D_Ein rigoroses Design für den Tisch Pegaso, der dazu konzipiert ist, auch für große Dimensionen anzunehmen. Seine extrem leichte Verbundplatte mit „Sandwich“-Struktur besteht aus einer Mittellage aus Holz zwischen zwei Aluminiumplatten, die an der Oberseite und an den Umfangskanten mit einer Schicht aus gebürstetem weißem Acrylharz oder mit einem Furnier aus heller Eiche, schwarzer Eiche oder Nussbaum Canaletto verkleidet sind. Die Schlichtheit und formale Nüchternheit der Tischplatte steht im Kontrast zu den geschwungenen Formen des Gestells aus Aluminium, glänzend oder mit Epoxidpulver-Beschichtung.

E_La mesa Pegaso se caracteriza por un diseño riguroso, estudiado para alcanzar dimensiones significativas, que se propone con un tablero en madera compuesta extremadamente ligero gracias a la estructura de tipo "sandwich", formada por madera listonada recubierta a ambos lados por placas de aluminio revestidas en la parte superior y bordes perimetrales por una lámina de resina acrílica blanca cepillada o enchapado en roble claro, roble negro o nogal canaletto. Las líneas limpias y sencillas del tablero contrastan con las formas sinuosas de la estructura, elaborada en aluminio brillante o barnizado con polvo epoxi.

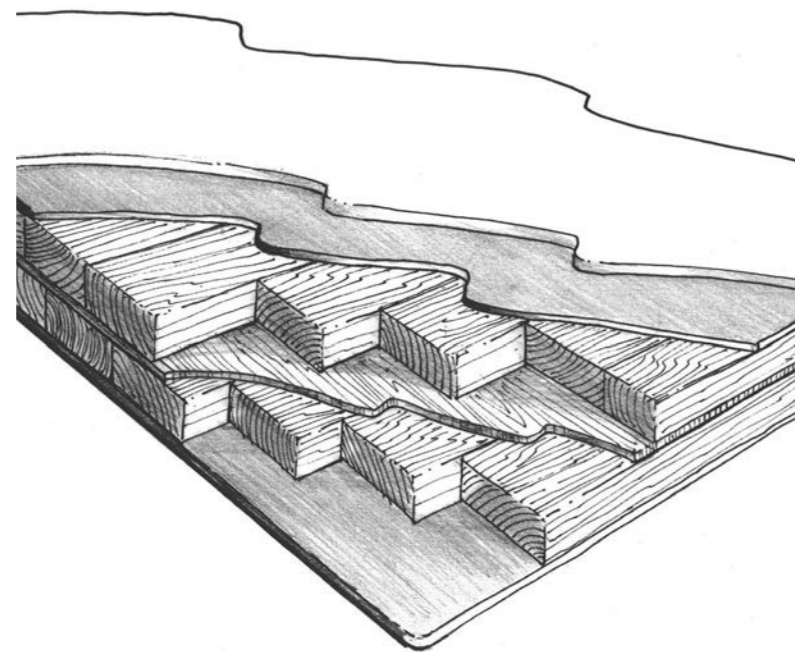

PEGASO Wood
Angelotti & Cardile



PEGASO Wood
Angelotti & Cardile



PEGASO Wood
Angelotti & Cardile



PEGASO Solid
Angelotti & Cardile



SUSU

Sezgin Aksu, Silvia Suardi

I Coffee table con struttura in tondino piegato in acciaio verniciato con polveri epossidiche e top in HPL. La superficie del piano è disponibile con finitura bianca o nero lava, in questo caso con una pregevole profondità materica della texture.

EN This is a coffee table with curved steel rod frame painted with epoxy powders and a HPL top. The top is available in a white or lava black finish, the latter with a wonderful depth of texture.

F Table basse à structure en tiges d'acier pliées peintes en époxy et plateau en HPL. La surface du plateau est disponible avec une finition blanche ou noir lave, dans ce cas avec une merveilleuse profondeur de texture.

D Couchtisch mit Gestell aus gebogenen Stahlstäben, mit Epoxidpulver-Lackierung und HPL-Platte. Die Tischfläche ist in Weiß oder in lavaschwarz erhältlich, die letztere mit einer wundervollen Strukturtiefe.

E Mesita de café con estructura formada por varillas plegadas realizadas en acero barnizado con polvos epoxi y tablero en HPL. La superficie del tablero está disponible con acabados en blanco o negro lava, logrando en este caso una preciada profundidad matérica de la textura.



ø 60 x h 35 cm



JOLLY

Caimi Lab

I_Tavolini con piano disponibile in laminato stratificato HPL, finitura bianco o nero lava, oppure in vetro spessore 12 mm, temperato e molato. Colonna in acciaio cromato o verniciato con polveri epossidiche. Basi in acciaio verniciato con polveri epossidiche o rivestite in acciaio inossidabile lucido. Le basi sono dotate di predisposizione per il fissaggio a terra. I piani in vetro sono applicati alla struttura mediante speciali dischi in acciaio inossidabile.

EN_Coffee tables with tops in HPL, white or lava black finish, or in 12 mm tempered polished glass. The column comes in chrome-plated or epoxy powder-coated steel. Bases are in epoxy powder-coated steel, or plated in polished stainless steel. Bases can also be anchored to the floor. Glass tops are applied to the structure using special stainless steel disc fasteners.

F_Tables avec plan disponible en laminé HPL, finissage blanc ou noir lave, ou bien en verre 12 mm, trempé et biseauté. Colonne en acier chromé ou peint en époxy. Bases en acier peint en époxy ou revêtues en acier inox brillant. Les bases sont prédisposées pour être fixées au sol. Les plans en verre sont appliqués à la structure avec des disques spéciaux en acier inox.

D_Tischchen mit Platte aus mehrschichtiges HPL-Laminat Oberfläche weiß oder lavaschwarz, oder aus gehärtetem und geschliffenem 12 mm-Glas. Säule aus verchromtem oder pulverbeschichtetem Stahl. Bodenplatte pulverbeschichtet oder mit glänzender Edelstahlbeschichtung. Die Bodenplatte verfügt über eine Vorrichtung für die Bodenbefestigung. Die Glastischplatten können dank besonderer Edelstahlscheiben am Untergestell angebracht werden.

E_Mesitas con plano disponible en laminado estratificado HPL, acabado en blanco o negro lava negro, o en cristal templado de 12 mm. de grosor y molturado. Columna de acero cromado o pintado con polvos epoxi. Bases de acero recubiertas con polvos epoxi o revestidas en acero inox brillante. Las bases vienen equipadas para anclarse al suelo. Las repisas de vidrio se aplican a la estructura a través de especiales discos de acero inox.

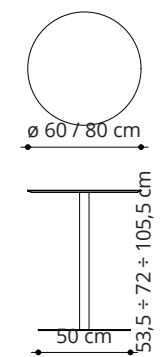



CICERONE

Lorenzo Stano

I_Tavolini con piano disponibile in laminato stratificato HPL oppure in vetro spessore 12 mm, temperato e molato. Colonna in acciaio verniciato con polveri epossidiche. Basi in acciaio verniciato con polveri epossidiche e rivestite in acciaio inossidabile lucido. Le basi sono dotate di predisposizione per il fissaggio a terra. I piani in vetro sono applicati alla struttura mediante speciali dischi in acciaio inossidabile. La struttura di sostegno del piano dei tavolini Cicerone è dotata di ganci portaborse ed è realizzata in fusione di alluminio verniciato con polveri epossidiche.

EN_Coffee tables with tops in multilayer HPL laminate or in 12 mm tempered, polished glass. The column comes in epoxy powder-coated steel. Bases are in epoxy powder-coated steel and plated in polished stainless steel. Bases can also be anchored to the floor. Glass tops are applied to the structure using special stainless steel disc fasteners. The support structure of the Cicerone coffee tables top is equipped with bag hooks and is made of epoxy powder coated aluminum casting.

F_Tables avec plan disponible en stratifié HPL ou en verre épaisseur 12 mm, trempé et biseauté. Colonne en acier peint en époxy. Bases en acier peint en époxy et revêtues en acier inox brillant. Les bases sont prédisposées pour être fixées au sol. Les plans en verre sont appliqués à la structure avec des disques spéciaux en acier inox. La structure qui soutient le plan des tables basses Cicerone est munie de crochets pour les sacs à main, elle est réalisée en fonte d'aluminium peint en époxy.

D_Tischchen mit Platte aus mehrschichtigem HPL-Laminat oder aus gehärtetem und geschliffenem 12 mm-Glas. Säule aus pulverbeschichtetem Stahl. Bodenplatte pulverbeschichtet und mit glänzender Edelstahlbeschichtung. Die Bodenplatte verfügt über eine Vorrichtung für die Bodenbefestigung. Die Glastischplatten können dank besonderer Edelstahlscheiben am Untergestell angebracht werden. Das Untergestell der Cicerone-Tischchen verfügt über Haken zum Aufhängen von Taschen und besteht aus Aluminiumguss, pulverbeschichtet.

E_Mesitas con plano disponible en laminado HPL o en vidrio templado de 12 mm. de grosor y molturado. Columna de acero pintado con polvos epoxi. Bases de acero recubiertas con polvos epoxi y revestidas en acero inox brillante. Las bases vienen equipadas para anclarse al suelo. Las repisas de vidrio se aplican a la estructura a través de especiales discos de acero inox. La estructura de apoyo de la repisa de las mesitas Cicerone va equipada con colgadores para bolsos y esta' realizada en aluminio fundido pintado con polvo epoxi.

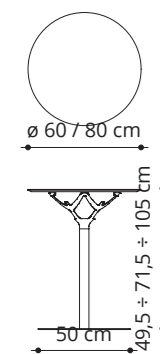



KALEIDOS

Michele De Lucchi, Sezgin Aksu

I_Kaleidos ha una linea pura, arricchita dalla particolarissima finitura superficiale della scocca che le dona effetti ottici tridimensionali e riflessi sorprendenti; la particolare texture conferisce inoltre un'inedita piacevolezza al tatto. Per la scocca, costituita da un unico pezzo, è stato scelto un poliammide riciclabile. Le strutture portanti in acciaio sono disponibili in diverse varianti.

EN_Kaleidos has pure lines, enriched by the unique surface of the seat, giving three-dimensional optical effects and wonderful reflections; in addition, the particular texture is unusually pleasing to the touch. The shell is made of a single piece in recyclable polyamide. The steel support frames are available in different models.

F_Kaleidos présente une ligne propre, enrichie par une finition de surface unique de la coque qui lui confère des effets optiques tridimensionnels et des reflets surprenants. La texture ainsi définie permet de réaliser une surface unique au toucher. La coque, en une seule pièce, est réalisée en polyamide recyclable. Les structures portantes en acier sont disponibles dans plusieurs variantes.

D_Kaleidos zeichnet sich durch klare Linien aus, die durch die besondere Oberflächenverarbeitung der Sitzschale betont werden, welche für dreidimensionale Effekte und schöne Reflektionen, sowie dafür sorgt, dass das Material sich sehr angenehm anfühlt. Die Sitzschale besteht aus einem einzigen Stück recycelbaren Polyamid. Das Stuhlgestell aus Stahl existiert in verschiedenen Ausführungen.

E_Kaleidos tiene una línea pura, enriquecida por el especialísimo acabado superficial del bastidor que le proporciona efectos ópticos tridimensionales y reflejos sorprendentes; además, su particular textura ofrece un inédito placer al tacto. Para el bastidor, constituido por una pieza única, se ha elegido una poliamida reciclable. Las estructuras portantes de acero están disponibles en diferentes variantes.

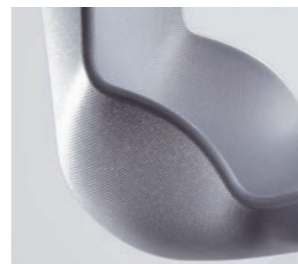
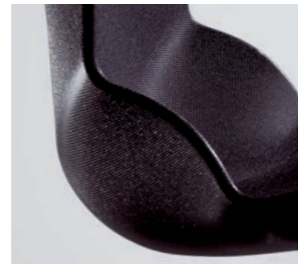





KALEIDOS Stool

Michele De Lucchi, Sezgin Aksu

I Lo sgabello Kaleidos ha una linea pura, arricchita dalla particolarissima finitura superficiale della scocca che le dona effetti ottici tridimensionali e riflessi sorprendenti; la particolare texture conferisce inoltre un'inedita piacevolezza al tatto. Per la scocca, costituita da un unico pezzo, è stato scelto un poliammide riciclabile. Strutture realizzate in tondino di acciaio cromato.

EN The Kaleidos stool has pure lines, enriched by the very special finishing of the seat surface, which offers three-dimensional optical effects and pleasing reflections; the unusual texture confers a totally new and pleasant tactile effect. A recyclable polyamide was selected for the seat, consisting of just one piece. Structural frames in chrome plated steel rod.

F Le tabouret Kaleidos a une ligne pure, enrichie d'une finition superficielle de la coque très particulière qui lui donne des effets optiques tridimensionnels et des reflets surprenants; la texture particulière apporte aussi une touche agréable inédite. La coque, constituée d'une seule pièce, est composée d'un polyamide recyclable. Structures réalisées en rond d'acier chromé.

D Der Hocker Kaleidos verfügt über eine klare Linie, aufgewertet durch die spezielle Oberfläche der Sitzschale, die ihm dreidimensionale Optikeffekte und überraschende Reflexe schenkt; die besondere Textur verleiht den Stühlen außerdem eine Beschaffenheit, die sich unvergleichlich angenehm anfühlt. Für den Sitz, der aus einem einzigen Stück angefertigt ist, wurde ein zu 100% recyclebares Polyamid gewählt. Das Untergestell besteht aus verchromtem Rundstahl.

E El taburete Kaleidos tiene una línea pura, enriquecida por el especialísimo acabado superficial del armazón que le proporciona efectos ópticos tridimensionales y reflejos sorprendentes; la especial textura proporciona un inédito placer al tacto. Para el armazón, constituido por una pieza única, se ha elegido una poliamida reciclable. La estructura consta de una varilla de acero cromado.

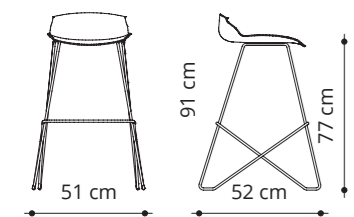
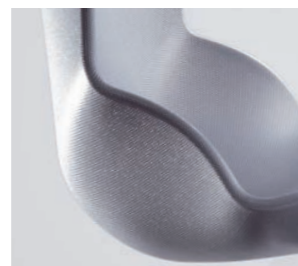
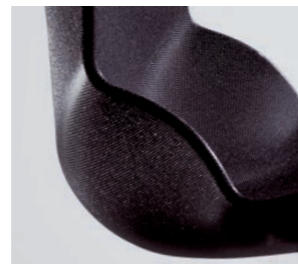

KALEIDOS Beam

Michele De Lucchi, Sezgin Aksu

I_Kaleidos ha una linea pura, arricchita dalla particolarissima finitura superficiale della scocca che le dona effetti ottici tridimensionali e riflessi sorprendenti; la particolare texture conferisce inoltre un'inedita piacevolezza al tatto. Per la scocca, costituita da un unico pezzo, è stato scelto un poliammide riciclabile. Travi e gambe sono in acciaio verniciato con polveri epossidiche.

EN_Kaleidos has pure lines, enriched by the unique surface of the seat, giving three-dimensional optical effects and wonderful reflections; in addition, the distinct texture is unusually pleasing to the touch. The shell is made of a single piece in recyclable polyamide. Beams and legs are made in powder-coated steel.

F_Kaleidos présente une ligne propre, enrichie par une finition de surface unique de la coque qui lui confère des effets optiques tridimensionnels et des reflets surprenants. La texture ainsi définie permet de réaliser une surface unique au toucher. La coque, en une seule pièce, est réalisée en polyamide recyclable. Poutres et piétements sont en acier peint en époxy.

D_Kaleidos zeichnet sich durch klare Linien aus, die durch die besondere Oberflächenverarbeitung der Sitzschale betont werden, welche für dreidimensionale Effekte und schöne Reflektionen, sowie dafür sorgt, dass das Material sich sehr angenehm anfühlt. Die Sitzschale besteht aus einem einzigen Stück recycelbaren Polyamid. Die Traversen und Standfüße aus pulverbeschichtetem Stahl sind.

E_Kaleidos tiene una línea pura, enriquecida por el especialísimo acabado superficial del bastidor que le proporciona efectos ópticos tridimensionales y reflejos sorprendentes; además, su particular textura proporciona un inédito placer al tacto. Para el bastidor, constituido por una pieza única, se ha elegido una poliamida reciclable. Las vigas y patas son de acero pintado con polvos epoxi.

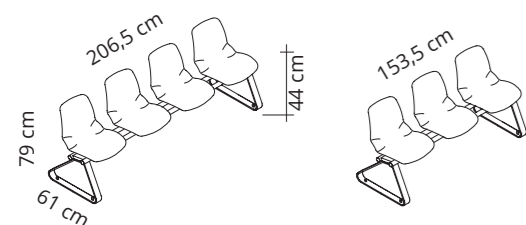
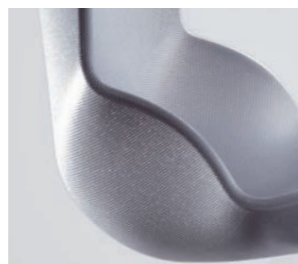
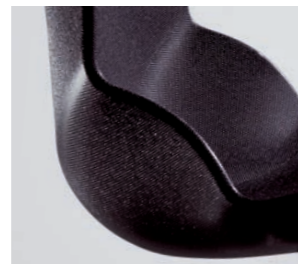

ULISSE

Caimi Lab

I Sistema di sedute modulari con scocche e tavolini realizzati in lamiera di acciaio forata verniciata con polveri epossidiche. I supporti, le travi e le particolari basi coniche sono in acciaio verniciato con polveri epossidiche.

EN Modular beam seating system with seats and side tables in epoxy powder-coated perforated steel sheet. The supports, the beams and the conical bases are made from epoxy powder-coated steel.

F Système modulaire de sièges sur poutre avec coquess et tables réalisées en tôle d'acier perforée peint en epoxy. Les supports, les poutres et les bases coniques très particulières sont en acier peint époxy.

D Modulare Traversensitzbank mit Untergestell und Tischen aus lackiertem gelochtem Stahlblech. Halterungen, Träger und die speziellen kegelförmigen Beine bestehen aus epoxypulverlackiertem Stahl.

E Sistema de asientos modulares con armazones y mesas de chapa de acero perforada recubierta con polvo epoxi. Los soportes, las vigas y las peculiares bases cónicas son de acero pintado con polvo epoxi.

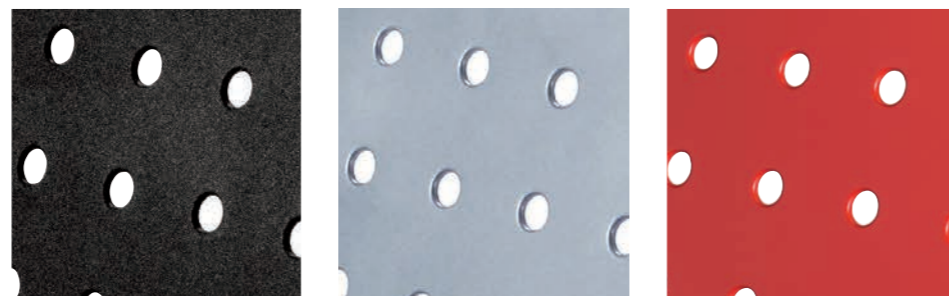
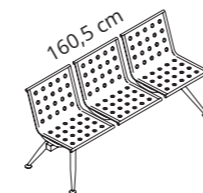
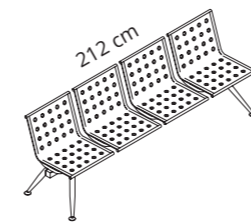
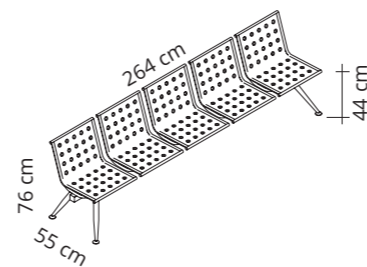



Shelving systems

I Sistemi di scaffalature che vanno oltre il semplice concetto di libreria, ripiano o contenitore. Pur assolvendo perfettamente a queste funzioni, si trasformano in elementi iconici di interior design. Diversi stili, con soluzioni molto caratterizzanti e protagoniste, altre votate invece alla pulizia formale. Dall'ufficio, alla casa, passando per il contract, questi sistemi offrono eleganza e funzionalità.

EN This shelving system goes beyond the simple concept of a bookcase, shelf or storage space. While perfectly fulfilling these functions, they also become iconic elements of interior design. Available in different styles, there are solutions that are filled with character and able to dominate a space, while others offer much more formal simplicity. From the office to the home to the contract industry, these systems are both elegant and practical.

F Des systèmes d'étagères allant outre la simple notion de bibliothèque, d'étagère ou de conteneur. Tout en remplissant parfaitement ces fonctions, ils se transforment en éléments emblématiques du design d'intérieur. Différents styles, avec des solutions très marquantes et protagonistes, d'autres plutôt consacrées à la propreté formelle. Du bureau à la maison, en passant par les collectivités, ces systèmes offrent élégance et fonctionnalité.

D Regalsysteme, die über das einfache Konzept eines Bücherschranks, Regals oder Stauraums hinausgehen. Zwar erfüllen sie all diese Funktionen perfekt, doch gleichzeitig stellen sie ikonische Elemente der Innenarchitektur dar. Verschiedene Stile, einige mit persönlichen und ausdrucksstarken Lösungen, andere mit formaler Schlichtheit. Ob im Büro, zu Hause oder in öffentlichen Räumen: diese Systeme bieten Eleganz und Funktionalität.

E Sistemas de estanterías que trascienden el mero concepto de librería, repisa o contenedor. A pesar de cumplir perfectamente con dichas funciones, se transforman en elementos icónicos para el diseño de interiores. Diferentes estilos: soluciones definidas y destinadas al protagonismo se alternan con otras caracterizadas por la sencillez de las formas. De la oficina al hogar, sin olvidar el sector del contract, estos sistemas resultan elegantes y funcionales.



BIG

Marc Sadler

Ideata quasi come un componente architettonico, Big è una libreria in metallo caratterizzata da robusti montanti in alluminio estruso con sezione a "T" e da ripiani in lamiera con bordo frontale decisamente importante, visivamente assimilabili a ripiani in muratura. Accentua questo aspetto la finitura bianco opaco, molto simile ad una muratura rasata a gesso e imbiancata. Le sue forme decise e ben delineate la rendono un "oggetto polifunzionale", in grado di caratterizzare indifferentemente ambienti moderni, hi-tech, classici o storici.

EN_Conceived almost as an architectural component, Big is a metal bookcase made of sturdy extruded aluminum uprights forming a "T" section and shelves in metal sheet, presenting a visually prominent front edge that gives the appearance of masonry shelves. The matt white finish accentuates this impression as it is highly reminiscent of brickwork stripped back to plaster and whitewashed. The pronounced and well-delineated shapes make this a multifunctional object that can fit equally well into a modern, hi-tech, classic or historical environment..

F_Big est une bibliothèque en métal, conçue presque comme un élément architectural. Elle se distingue par ses montants robustes en aluminium extrudé avec profil en T et des étagères en tôle avec un rebord frontal très marqué, donnant l'idée d'étagères en maçonnerie. Cet aspect est renforcé par le finissage en blanc opaque, ressemblant beaucoup à une maçonnerie plâtrée et blanchie à la chaux. Ses formes bien définies en font un "objet polyvalent", capable de s'intégrer indifféremment dans des intérieurs modernes, hi-tech, classiques ou historiques.

D_Einem architektonischen Bauelement nachempfunden, ist Big ein Metallregal mit starken T-Querschnitt-Ständern aus stranggepresstem Aluminium und Regalböden aus Blech mit einer besonders betonten Vorderkante, deren Aussehen an Mauerwerkablagen erinnert. Dieses Aussehen wird weiter von der matt-weißen Oberflächenbehandlung hervorgehoben, die einer angemalten Gipswand stark ähnelt. Die entschlossenen, klar definierten Linien machen aus Big ein "Mehrfunktions-Objekt", das genauso gut zu modernen, Hi-Tech-Räumen wie zu klassischen Räumen mit geschichtlichem Flair passt.

E_Concebida como si fuese un componente arquitectónico, Big es una librería de metal que se caracteriza por sus sólidos montantes de aluminio de extrusión con sección en "T" y por los estantes de metal con un característico borde anterior, muy parecidos a los estantes de mampostería. Acentúa este aspecto el acabado blanco opaco. Gracias a su diseño esencial y definido es un "objeto multifuncional" que logra caracterizar tanto los ambientes modernos y hi-tech como los clásicos.









Clicca e scarica
il pdf.
Click and download
pdf file.







L_Montanti in alluminio verniciato con polveri epossidiche colore bianco opaco o nero opaco.

EN_Uprights in epoxy powder-coated mat white or mat black.

F_Montants en aluminium peint en époxy blanc mat ou noir mat.

D_Seitenteil aus mit Epoxypulver beschichtetem Aluminium, mattweiß oder mattschwarz.

E_Laterales de aluminio pintado con polvo epoxi, color blanco mate o negro mate.

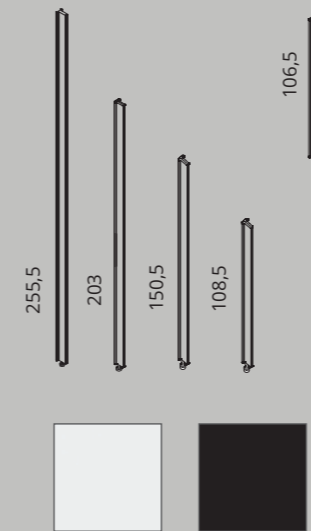

L_Ripiani in acciaio verniciato con polveri epossidiche colore bianco opaco o nero opaco.

EN_Shelves in epoxy powder-coated steel, mat white or mat black.

F_Tablettes en acier peint en époxy, blanc mat ou noir mat.

D_Regalböden aus mit Epoxypulver beschichtetem Stahl, mattweiß oder mattschwarz.

E_Estantes de acero pintado con polvos epoxi color blanco mate o negro mate.

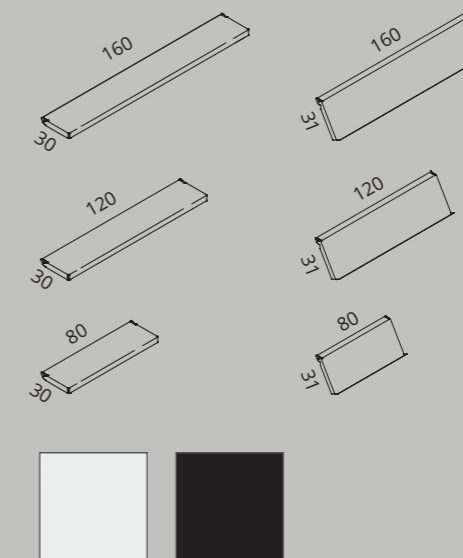

Dimensions in cm

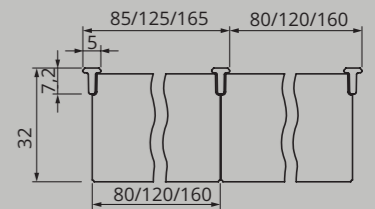
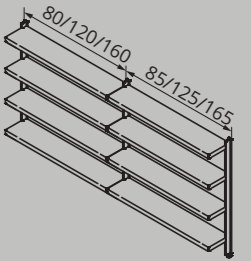

SOCRATE

Caimi Lab

I Socrate è un sistema modulare di librerie in metallo caratterizzate dall'estrema flessibilità di composizione, adatto a soddisfare molteplici esigenze sia in termini di spazio che di stile. Il sistema Socrate è composto da una struttura base fatta di montanti, schienali e ripiani e da una serie molto ampia di originali accessori facilmente applicabili e intercambiabili.

EN Socrate is a modular metal shelving system whose remarkable flexibility enables it to meet all sorts of demands of space and style. The Socrate system combines uprights, panels and shelves to form a basic structure that can accommodate a very wide range of original accessories that are easy to attach and swap around.

F Socrate est un système modulaire de bibliothèque avec une structure métallique caractérisée par la flexibilité extrême de sa composition, en mesure de répondre aux différentes exigences à la fois en termes d'espace et de style. Le système Socrate comprend une structure de base composée de montants, fonds et étagères et une gamme très vaste d'accessoires originaux, interchangeables et faciles à appliquer.

D Socrate ist ein modulares Regalsystem aus Metall, das sich durch extreme Flexibilität in der Zusammenstellung auszeichnet und den unterschiedlichsten Anforderungen in puncto Stil und Raumgestaltung genügen kann. Das System Socrate besteht aus einer Struktur mit Ständern, Rückenelementen und Regalböden sowie aus einer breit gefächerten Auswahl an originellen Zubehörelementen, die einfach angebracht und ausgetauscht werden können.

E Socrate es un sistema modular de librerías metálicas que se caracteriza por la libertad de composición, que logra atender a las múltiples necesidades tanto de espacio como de estilo. El sistema Socrate consta de una estructura básica de montantes, traseras y estantes, así como de un conjunto muy amplio de accesorios originales fácilmente ensamblables e intercambiables.



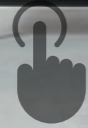

Click and watch
the video.













I Il sistema Socrate si arricchisce attraverso una nuova opzione per le chiusure scorrevoli. In questo caso si tratta di elementi in vetro cannettato che, in base alle condizioni di luce, offrono un'elegante scomposizione ottica degli oggetti contenuti all'interno della libreria.

EN This system is enriched by a new solution for sliding closings. In this case, the closings are made of ribbed glass which, depending on the light, elegantly refracts whatever items are in the bookcase.

F Le système Socrate s'enrichit d'une nouvelle option aux fermetures coulissantes. Dans ce cas, il s'agit d'éléments en verre cannelé qui, en fonction des conditions de lumière, offrent une élégante décomposition optique des objets contenus dans la bibliothèque.

D Das System Socrate wird durch eine neue Option mit Schiebetüren ergänzt. Hier handelt es sich um Elemente aus geripptem Glas, die den im Regal befindlichen Objekten je nach Lichtverhältnissen einen eleganten optischen Effekt verleihen.

E El sistema Socrate se enriquece con una nueva opción con sus puertas correderas. En este caso se trata de elementos elaborados en vidrio acanalado que, en función de la iluminación, proponen una elegante descomposición óptica de los objetos contenidos en el interior de la librería.





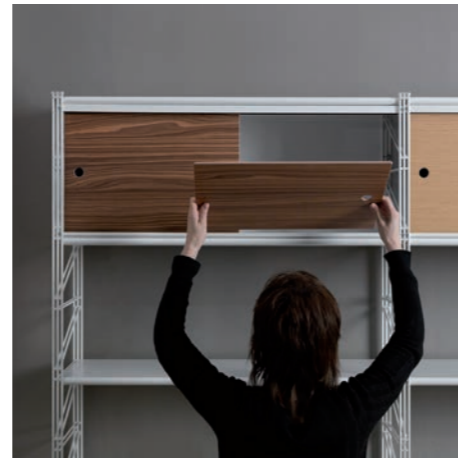









Dimensions in cm

I_Montanti e crociere disponibili in acciaio verniciato con polveri epossidiche colore bianco opaco, grigio metallizzato o nero. Schienali in acciaio pieno verniciati con polveri epossidiche colore bianco opaco, grigio metallizzato o nero.

EN_Uprights and bracing crosses in epoxy powder-coated steel, mat white, metal grey or black. Backs in solid epoxy powder-coated steel, mat white, metal grey or black.

F_Montants et croisillons disponibles en acier peint époxy blanc mat, gris métallisé ou noir. Dossiers en acier plein peint époxy, blanc mat, gris métallisé ou noir.

D_Seitenteile und Kreuze erhältlich aus Stahl mit Epoxypulver beschichtetem, in den Farben mattweiß, grau metallic oder schwarz. Rückwände aus Vollstahl, mit Epoxypulver beschichtet in den Farben mattweiß, grau metallic oder schwarz.

E_Laterlaes y soportes traseros respaldos disponibles en acero pintado con polvo epoxi color blanco mate, gris metalizado o negro. Respaldos de acero compacto pintado con polvo epoxi color blanco mate, gris metalizado o negro.

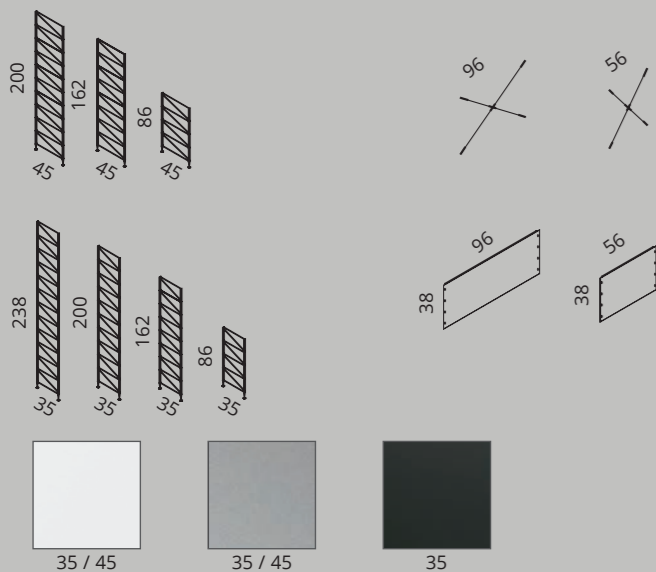

I_Ripiani in vetro temperato trasparente o in acciaio pieno o microforato, verniciati con polveri epossidiche colore bianco opaco, grigio metallizzato o nero, disponibili con o senza bordo rialzato posteriore.

EN_Shelves in transparent tempered glass or in solid/micro-perforated epoxy powder-coated steel, matt white, metal grey or black, available with or without rear raised edge.

F_Tablettes en verre trempé transparent ou en acier plein ou micro-perforé peint en époxy blanc mat, gris métallisé ou noir, disponibles avec ou sans rebord postérieur surélevé.

D_Regalböden aus gehärtetem Glas oder Vollstahl oder mikroperforiertem Stahl, mit Epoxypulver beschichtet in den Farben mattweiß, grau metallic oder schwarz, mit oder ohne erhöhter Hinterkante erhältlich.

E_Estantes de vidrio templado transparente o de acero de alma llena o perforado, pintados con polvos epoxi blanco mate, gris metalizado o negro, disponibles con o sin borde posterior en relieve.

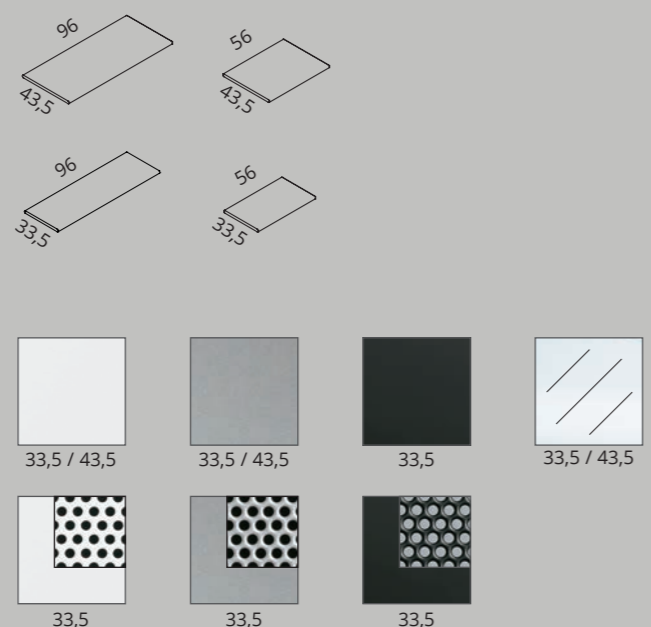

I_Ripiani/espositori inclinati in acciaio microforato verniciato con polveri epossidiche colore bianco opaco, grigio metallizzato o nero.

EN_Sloped shelves/display units in epoxy powder-coated micro-perforated steel, matt white, metal grey or black.

F_Présentoirs inclinés en acier micro-perforé peint en époxy, blanc mat, gris métallisé ou noir.

D_Schrägausstellungstablare/-regalfächer aus mit Epoxypulver beschichtetem Stahl in den Farben mattweiß, grau metallic oder schwarz.

E_Estantes expositores inclinados en acero pintado con polvo epoxi, blanco mate, gris metalizado o negro.

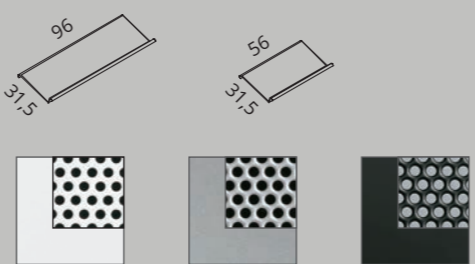

I_Chiusure laterali e chiusure interne in acciaio pieno verniciato con polveri epossidiche colore bianco opaco, grigio metallizzato o nero.

EN_Side and internal closures in epoxy powder-coated solid steel, mat white, metal grey or black.

F_Fermetures latérales et internes en acier plein peint époxy blanc mat, gris métallisé ou noir.

D_Seitenteile und Innenverkleidungen aus Epoxypulver beschichtetem Stahl in den Farben mattweiß, grau metallic oder schwarz.

E_Cierres laterales y internas de acero compacto pintado con polvos epoxi color blanco mate, gris metalizado o negro.

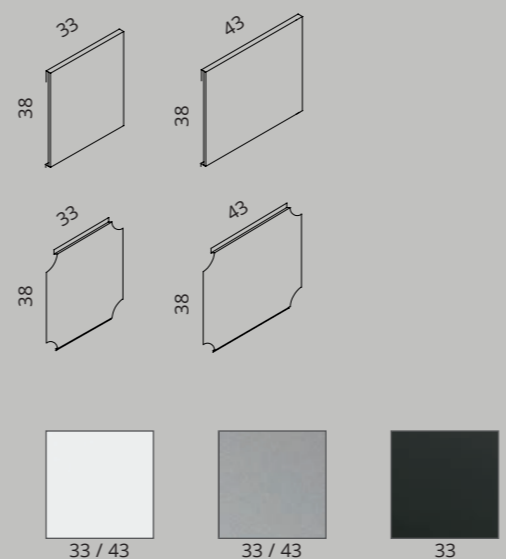

I_Chiusure scorrevoli disponibili in acciaio verniciato con polveri epossidiche, in MDF placcato alluminio impiallacciato legno oppure in vetro satinato, trasparente o cannettato. Guide in acciaio verniciato con polveri epossidiche.

EN_The sliding closings come in epoxy powder-coated steel, in MDF (aluminum plated wood veneered), satin, transparent or ribbed glass. Guides are available in epoxy powder-coated steel.

F_Les fermetures coulissantes existent en acier peint avec des poudres époxy, en MDF plaqué aluminium avec placage bois ou en verre satiné, transparent ou cannelé. Glissières en acier peint avec des poudres époxy.

D_Schiebetüren sind aus epoxidstaublackiertem Stahl, aus MDF-Holz mit Aluminiumüberzug, aus holzbeschichtetem MDF oder aus satiniertem, transparentem oder geripptem Glas erhältlich. Schienen aus epoxidstaublackiertem Stahl.

E_Puertas correderas de acero pintado con polvos epoxi, MDF revestido de aluminio, enchapado de madera o vidrio satinado, transparente o acanalado. Guías de acero pintado con polvos epoxi.

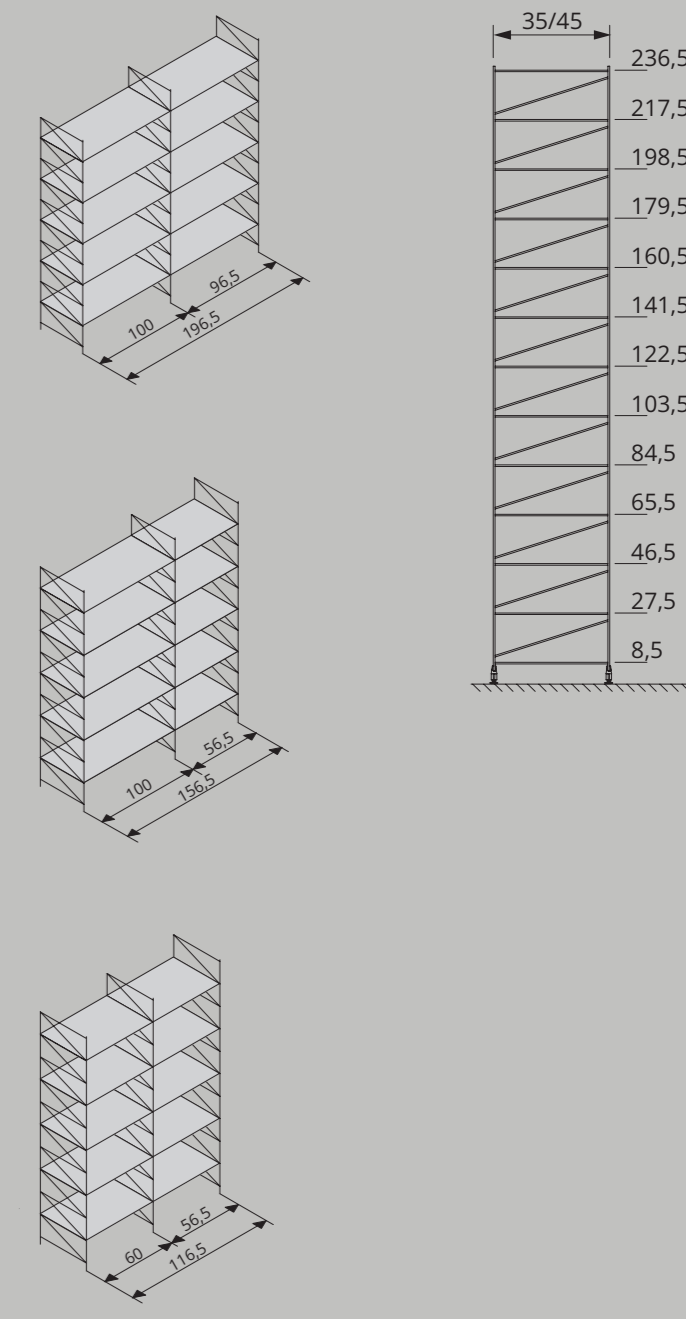
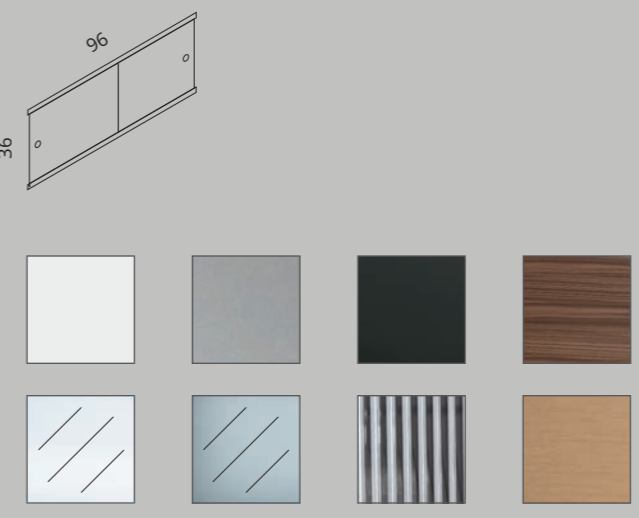

Dimensions in cm

I_Montanti e supporti disponibili in acciaio verniciato con polveri epossidiche colore bianco opaco o grigio metallizzato.

EN_Uprights and supports in epoxy powder-coated steel, mat white or metal grey.

F_Montants et supports disponibles en acier peint époxy blanc mat ou gris métallisé.

D_Seitenteile und Halterungen aus Epoxypulver beschichtetem Stahl, in den Farben mattweiß oder grau metallic.

E_Laterlaes y soportes disponibles en acero pintado con polvos epoxi color blanco mate o gris metalizado.

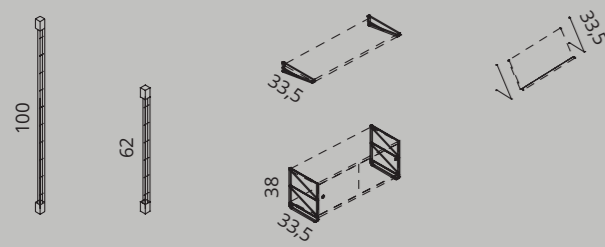

I_Ripiani in vetro temperato trasparente o in acciaio pieno o microforato, verniciati con polveri epossidiche colore bianco opaco o grigio metallizzato.

EN_Shelves in transparent tempered glass or in solid/micro-perforated epoxy powder-coated steel, matt white or metal grey.

F_Tablettes en verre trempé transparent ou en acier plein ou micro-perforé peint en époxy blanc mat ou gris métallisé.

D_Regalböden aus gehärtetem Glas oder Vollstahl oder mikroperforiertem Stahl, mit Epoxypulver beschichtet in den Farben mattweiß oder grau metallic.

E_Estantes de vidrio templado transparente o de acero de alma llena o perforado, pintados con polvos epoxi blanco mate o gris metalizado.

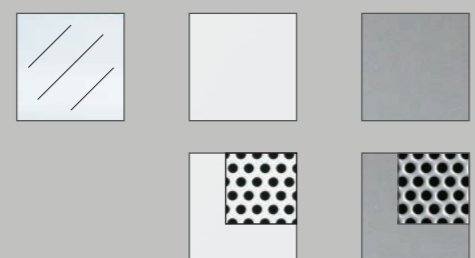
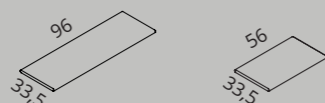

I_Ripiani/espositori inclinati in acciaio microforato verniciato con polveri epossidiche colore bianco opaco o grigio metallizzato.

EN_Sloped shelves/display units in epoxy powder-coated micro-perforated steel, matt white or metal grey.

F_Présentoirs inclinés en acier micro-perforé peint en époxy, blanc mat ou gris métallisé.

D_Schrägausstellungstablare/-regalfächer aus mit Epoxypulver beschichtetem Stahl, mattweiß oder grau metallic.

E_Estantes expositores inclinados en acero pintado con polvo epoxi, blanco mate o gris metalizado.

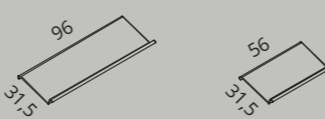

I_Chiusure laterali e chiusure interne in acciaio pieno verniciato con polveri epossidiche colore bianco opaco o grigio metallizzato.

EN_Side and internal closures in epoxy powder-coated solid steel, mat white or metal grey.

F_Fermetures latérales et internes en acier plein peint époxy blanc mat ou gris métallisé.

D_Seitenteile und Innenverkleidungen aus Epoxypulver beschichtetem Stahl in den Farben mattweiß oder grau metallic.

E_Cierres laterales y internas de acero compacto pintado con polvos epoxi color blanco mate o gris metalizado.

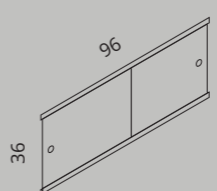
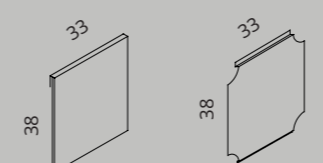

Dimensions in cm

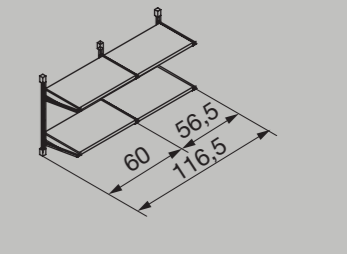
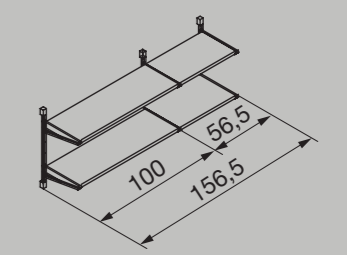
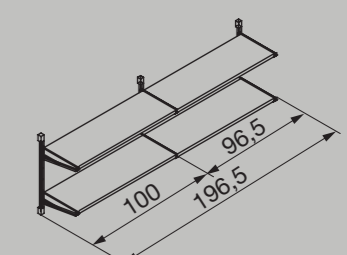
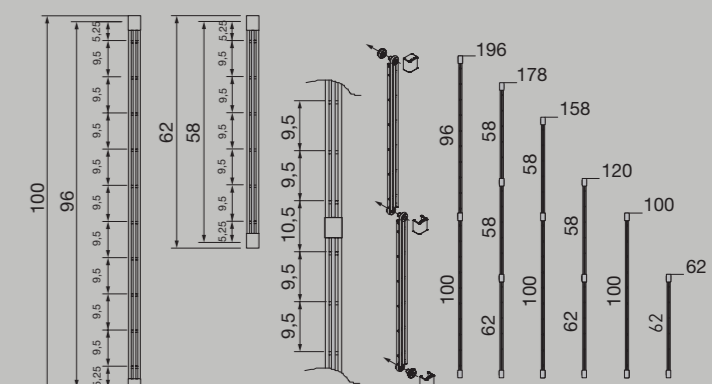

SOCRATE OUTDOOR

Mario Trimarchi, Caimi Lab

I_Socrate Outdoor è un sistema d'arredo per esterno, modulare e componibile, pensato come un elemento polivalente dotato di accessori che lo rendono funzionale per svariati utilizzi outdoor, per piccoli e grandi spazi. Composto da una struttura base fatta di montanti, crociere e griglie, realizzati in tondino di acciaio zincato e verniciato e da ripiani in metallo, in marmo, piani portavasi, griglie e contenitori realizzati in acciaio inox o zincato e verniciato. I differenti colori di strutture, ripiani e accessori possono essere combinati fra loro per un inedito effetto cromatico.

EN_Socrate Outdoor refers to a system of modular outdoor furniture. Socrate Outdoor items are designed to be multifunctional and come equipped with accessories for adapting them to any one of the various uses to which they can be put in a given place, be it small or large. Each item in the range consists of a basic frame of uprights, bracing crosses and grids of galvanized and coated steel that support metal or marble shelves, planter holders, meshes and containers made either of stainless steel or of powder-coated galvanized steel. Available in a variety of colours, the basic structures, shelves and accessories can be mixed and matched to achieve a personalized chromatic effect.

F_Socrate Outdoor est un système de mobilier d'extérieur, modulaire et assemblable, conçu comme un élément polyvalent avec des accessoires qui le rendent apte à diverses utilisations en extérieur, pour des espaces petits ou grands. Il se compose d'une structure de base comprenant des montants, des croisillons et grilles en tige d'acier galvanisé peint et des étagères en métal, en marbre, des tablettes porte-pots, des grilles et des récipients en acier inoxydable ou galvanisé et peint. Les différentes couleurs des structures, étagères et accessoires peuvent être assemblées entre elles pour obtenir un effet chromatique inédit.

D_Socrate Outdoor ist ein modulares Einrichtungssystem aus kombinierbaren Elementen für den Außenbereich. Es basiert auf dem Konzept eines durch Zubehör großen oder kleinen Räumen sowie verschiedenen Außenraum-Funktionen anpassbaren Mehrzweckelementes. Die Grundstruktur sieht Ständer, Kreuzelemente und Gitterelemente aus verzinktem und lackiertem Stahlrohr sowie Regalböden aus Metall und Marmor, Pflanzenablageflächen, Gitter und Behälter aus rostfreiem bzw. verzinktem und lackiertem Stahl vor. Die unterschiedlichen Farben der Strukturelemente, Regalböden und Zubehörelemente können miteinander kombiniert werden, um überraschende Farbeffekte zu erzielen.

E_Socrate Outdoor es un sistema modular de decoración para exteriores, concebido como elemento versátil que incorpora diversos accesorios para resultar más funcional a los diferentes espacios, tanto de pequeño como de gran tamaño. Consta de una estructura básica con montantes, crucetas y rejillas de acero galvanizado y pintado y de estantes de metal, mármol, repisas porta macetas, rejillas y contenedores de acero inoxidable o galvanizado y pintado. Se pueden combinar los diferentes colores de las estructuras, estantes y accesorios para conseguir un efecto cromático original.











Dimensions in cm

I_Montanti, crociere e schienali realizzati in acciaio zincato e verniciato con polveri epossidiche per esterni.

EN_Uprights, cross bars and back panels in galvanized steel and epoxy powder-coated for outdoor use.

F_Montants, croisillons et fonds en acier galvanisé et peint en époxy pour l'extérieur.

D_Seitenteile, Stabilisierungskreuze und Rückwände verfügbar in verzinktem bzw. pulverbeschichtetem Stahl für die Verwendung im Außenbereich.

E_Montantes, crucetas y traseras en acero galvanizado y pintado con polvos epoxi para uso exterior.

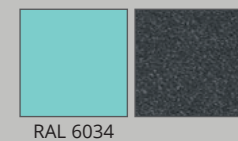
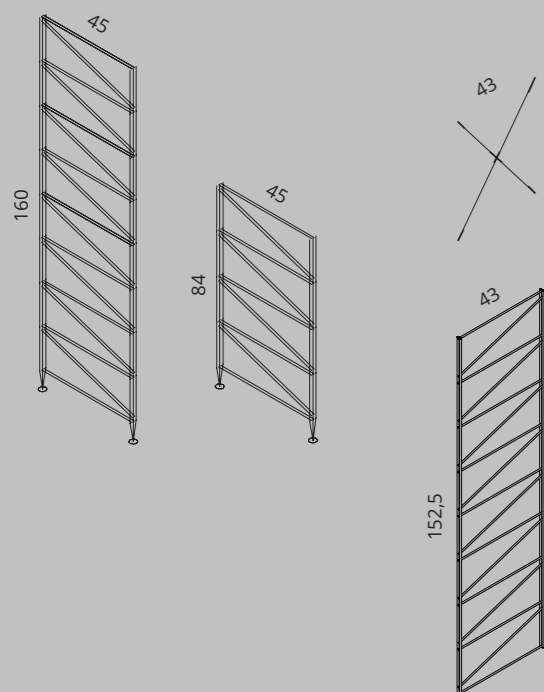

I_Ripiani in lamiera o in filo di acciaio realizzati in acciaio zincato e verniciato con polveri epossidiche per esterni.

EN_Shelves in metal sheet or steel wire in galvanized steel and epoxy powder-coated for outdoor use.

F_Étagères en tôle ou fil d'acier en acier galvanisé et peint en époxy pour l'extérieur.

D_Fachböden massiv oder aus Stahldraht verfügbar in verzinktem bzw. pulverbeschichtetem Stahl für die Verwendung im Außenbereich.

E_Estantes en chapa o en malla de acero en acero galvanizado y pintado con polvos epoxi para uso exterior.

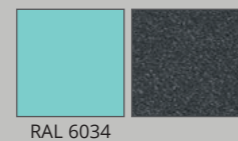
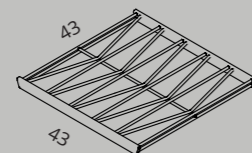
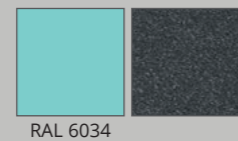
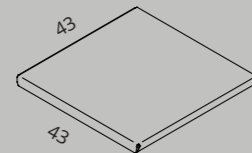

I_Ripiani stagni, vaschette e mensole realizzati in acciaio zincato e verniciato con polveri epossidiche per esterni.

EN_Tray and Watertight shelves in galvanized steel and epoxy powder-coated for outdoor use.

F_Étagères étanches, bacs et tablettes en acier galvanisé et peint en époxy pour l'extérieur.

D_Wasserundurchlässige Trays und Fachböden verfügbar in verzinktem bzw. pulverbeschichtetem Stahl für die Verwendung im Außenbereich.

E_Baldas estancas, bandejas y estantes en acero galvanizado y pintado con polvos epoxi para uso exterior.

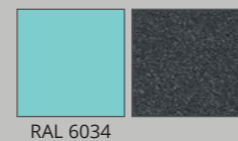
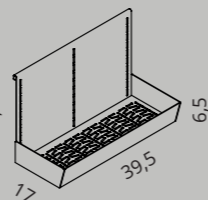
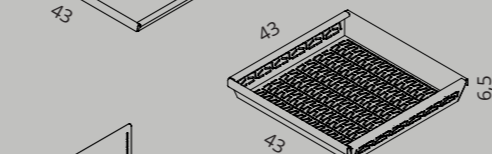
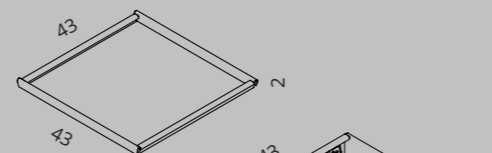

I_Ripiani in granito Serizzo completi di sottopiano in acciaio zincato e verniciato con polveri epossidiche per esterni.

EN_Serizzo granite shelves with undercounter in galvanized steel and epoxy powder-coated for outdoor use.

F_Étagères en granit Serizzo avec sous-plan en acier galvanisé et peint en époxy pour l'extérieur.

D_Fachböden aus Serizzo Granit mit Unterseite aus verzinktem bzw. pulverbeschichtetem Stahl für die Verwendung im Außenbereich.

E_Estantes de granito Serizzo que se completan con estructura en acero galvanizado y pintado con polvos epoxi para uso exterior.

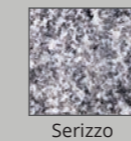
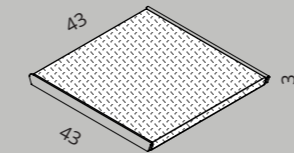

I_Contenitore in acciaio inox con ruote.

EN_Stainless steel container with wheels.

F_Récipient en acier inox avec roues.

D_Edelstahl-Container auf Rollen.

E_Recipiente de acero inoxidable con ruedas.

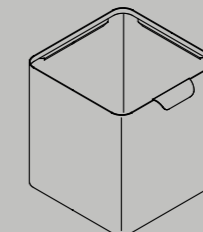
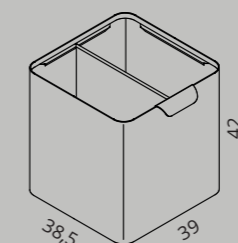

Dimensions in cm

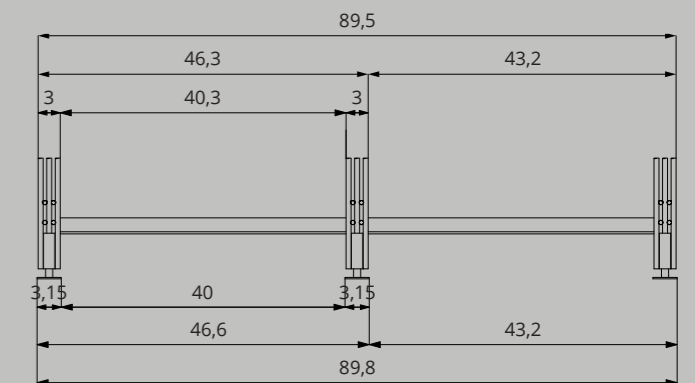
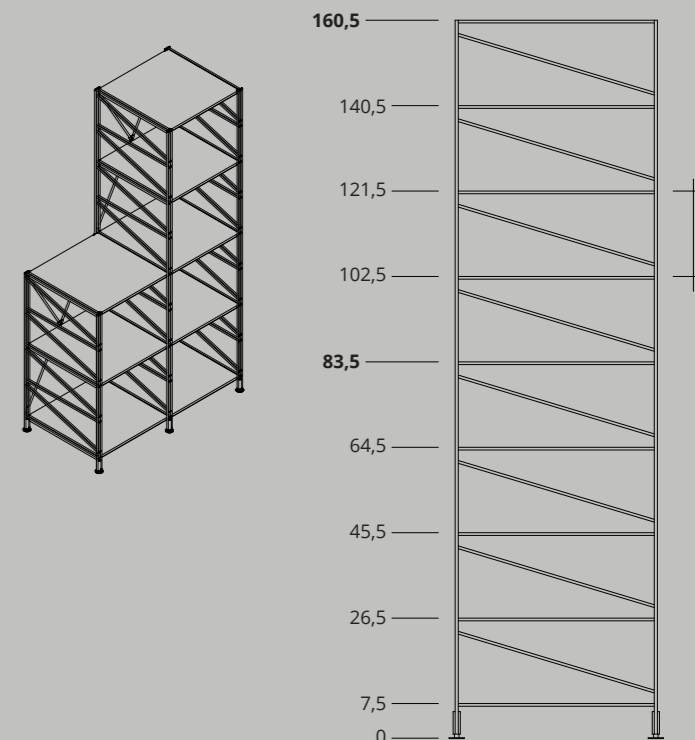

Bibliotech

I nostri sistemi di librerie possono vantare oltre 500 realizzazioni in tutto il mondo, numeri che descrivono oltre al design, la versatilità, la robustezza, la modularità, la semplicità di installazione e manutenzione e l'adattabilità post installazione alle mutate esigenze di utilizzo delle biblioteche. Sistemi ecosostenibili, riciclabili e sicuri.

EN Our shelving systems have been installed in more than 500 libraries worldwide, a number that reflects not only their design, but also their versatility, robustness, modularity, ease of installation and maintenance, and adaptability, even post-installation, to the changing needs of library users. Environmentally sustainable, recyclable, safe and secure systems.

F Nos systèmes de bibliothèques vantent plus de 500 réalisations à travers le monde ; des chiffres qui décrivent non seulement leur conception, mais aussi leur polyvalence, leur robustesse, leur modularité, leur facilité d'installation et d'entretien, ainsi que leur adaptabilité après installation aux exigences changeantes d'utilisation des bibliothèques. Il s'agit de systèmes éco-durables, recyclables et sûrs.

D Unsere Bibliothekssysteme wurden weltweit über 500 Mal installiert, eine Zahl, die mit Stolz erfüllt, weil sie nicht nur raffiniertes Design widerspiegelt, sondern auch Vielseitigkeit, Robustheit, Modularität, Installations- und Wartungsfreundlichkeit sowie Anpassungsfähigkeit an die sich ändernden Anforderungen der Nutzer von Bibliotheken. Umweltfreundliche, wiederverwertbare sowie zuverlässige und sichere Systeme.

E Nuestros sistemas de librerías están presentes en más de 500 proyectos alrededor del mundo. Estas cifras describen, además del diseño, su versatilidad, robustez, modularidad, simplicidad de instalación y mantenimiento, así como la capacidad de adaptarse, una vez concluida la instalación, a las necesidades de uso variables de las bibliotecas. Se trata de sistemas ecosostenibles, reciclables y seguros.



Download
Bibliotech
brochure



Clicca e scarica
il pdf.

Click and download
pdf file.





← Quartiere degli Elementi
↳ Quartiere di Elementi

← Quartiere degli Elementi
↳ Quartiere di Elementi

01021

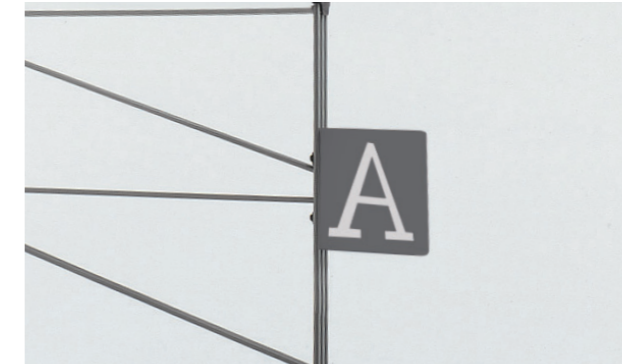

I_Espositore a tre ante in metacrilato con struttura di sostegno in acciaio cromato e verniciato.

EN_Three-flap panels display unit in methacrylate with supporting structure in chrome-plated and epoxy powder-coated steel.

F_Présentoir à trois volets en méthacrylate avec support en acier chromé et peint.

D_Aussteller mit drei Türen aus Methacrylat mit Stützstruktur aus verchromtem und beschichtetem Stahl.

E_Expositor de tres puertas de metacrilato con estructura de apoyo de acero cromado y pintado.





I ripiani in acciaio pieno o microforato sono realizzati con bordo frontale a doppio spessore arrotondato anti-infortunio. La piegatura laterale permette l'aggancio diretto al montante. Il ripiano e il fianco microforati facilitano la circolazione dell'aria migliorando l'aerazione dei libri e riducendo quindi la pericolosa formazione di umidità.

EN_The shelves, in solid or microperforated steel, feature a rounded, accident-preventing, double thickness, front edge. The side fold allows the direct link to the upright. The microperforated shelf and side make the air circulation easier, thus improving the ventilation of books and reducing the dangerous forming of humidity.

F_Les rayons en acier, plein ou microperforé, sont réalisés avec rebord frontal à double épaisseur avec arrondi de sécurité. Le pliage latéral permet de les fixer directement au montant. Le rayon et le côté microperforé facilitent l'aération des livres et réduisent le risque d'humidité.

D_Die Regale, aus glattem oder micro-perforiertem Stahl, verfügen über einen abgerundeten verletzungssicheren verstärktem Vorderrand. Die seitlichen Abkantungen ermöglicht das direkte Einhängen in den Ständern. Die Regalfläche und die Seitenwände mit Microperforation erleichtern die Luftzirkulation und verbessern die Belüftung der Bücher, wodurch gefährliche Feuchtigkeitsbildung verringert wird.

E_Los estantes de acero tienen un borde en la parte anterior de doble espesor redondeado anti-caída. El dobléz lateral permite engancharlos directamente al montante. El estante y el lateral microperforados facilitan la circulación del aire mejorando la aireación de los libros reduciendo así la peligrosa formación de humedad.

I ripiani possono essere montati in posizione dritta o inclinata.

EN_Shelves are fixable in either a level or an inclined position.

F_Les tablettes peuvent être montées droites ou inclinées.

D_Die Regalböden können gerade oder schräg montiert werden.

E_Los estantes pueden montarse en posición horizontal o inclinada.



I_Fermalibro scorrevole e inasportabile realizzato in tecnopolimero e acciaio cromato, si inserisce nella guida posteriore dei ripiani in lamiera di acciaio piena o microforata.

EN_Sliding and irremovable book-end carried out in high-tech polymer and chrome-plated steel to be put in the back slide of the shelves in solid or microperforated sheet-steel.

F_Serre-livres coulissant mais inamovible réalisé en techno-polymère et acier chromé, s'insère dans la glissière postérieure des rayons en tôle d'acier pleine ou microperforée.

D_Buchstütze verschiebbar und nicht abnehmbar, hergestellt aus Technopolymer und verchromtem Stahl, wird in die hintere Führung der Stahlböden (glatt oder micro-perforiert) eingeführt.

E_Sujetalibro corredizo y difícil a extraer realizado en tecnopolímero y acero cromado, se introduce en la guía posterior de los estantes en chapa de acero llena o microperforada.

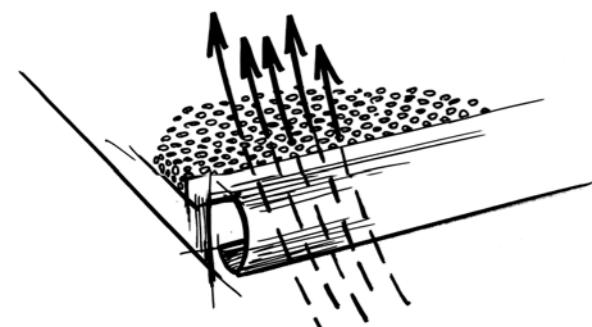

**More than 500
libraries furnished
around the world...**



Lycée Français Stendhal
Milano (Italy)



Biblioteca Museo De La Ciencia
Barcelona (Spain)



Maison de la Dance
Paris (France)



Biblioteca del Progetto, Triennale di Milano
(Italy)

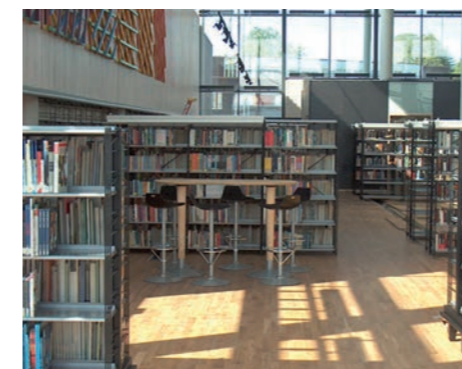

Library of Trondheim
(Norway)



Università di Bologna, Istituto di Psicologia
(Italy)



Biblioteca Comunale Ariostea
Ferrara (Italy)



Instituto Cervantes
Warsaw (Poland)



Biblioteca Università degli Studi
Udine (Italy)

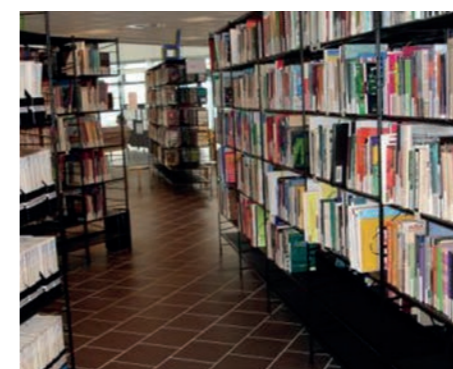

CVU Vita Holstebro
(Denmark)

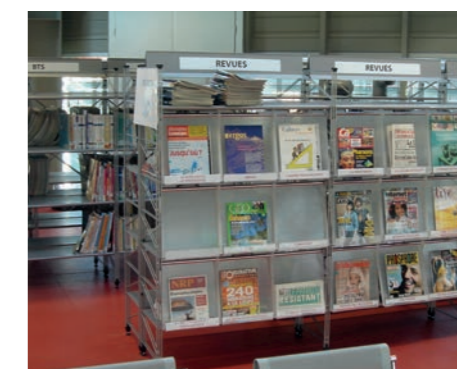

Lycée Deodat De Severac
Toulouse (France)



Library 10
Helsinki (Finland)

Communication & Meeting

I Sistemi di segnaletica e comunicazione completi di espositori in diversi formati e accessori, caratterizzati da forme che li rendono adatti ad ogni tipo di ambiente. I sistemi di comunicazione sono versatili e riconfigurabili, appositamente studiati per sale polifunzionali, conferenze e riunioni.

EN Signage and communication systems available in several different display formats and with accessories to suit any type of environment. The communication systems are versatile and reconfigurable, and have been specifically designed with multipurpose spaces, conference halls and meeting rooms in mind.

F Systèmes de signalétique et de communication complets avec des présentoirs de différents formats et des accessoires, caractérisés par des formes qui les rendent adaptés à tout type de situation. Les systèmes de communication sont aptes à des usages multiples et reconfigurables, spécialement conçus pour les salles polyvalentes, les conférences et les réunions.

D Beschilderungs- und Kommunikationssysteme mit Auslagen in verschiedenen Formaten und Zubehörelemente, die sich durch Formen auszeichnen, durch die sie sich für jeden Raum eignen. Die Systeme sind vielfach anwendbar und können umkonfiguriert werden. Sie sind eigens für Mehrzweck-Säle, Konferenz- und Versammlungsräume entworfen.

E Sistemas de señalización y comunicación que cuentan con expositores de diferentes formatos y accesorios. Se caracterizan por un diseño que se ajusta a todo tipo de ambientes. Estos sistemas son versátiles y reconfigurables, ya que están concebidos específicamente para salas multifuncionales, de conferencias y de reuniones.



MEETING

Caimi Lab

I Collezione di accessori per sale riunioni costituita da un profilo modulare a parete in alluminio satinato a cui si agganciano porta-tablet, portaoggetti, portabiti, lavagne in laminato e pannelli fonoassorbenti Snowsound.

EN Accessories for meeting rooms, comprised of a modular wall mounted frame in satin aluminum on which to install tablet mounts, holders, clothes hangers, laminate writing boards and Snowsound sound-absorbing panels.

F Collection d'accessoires pour salles de réunions avec profil modulaire à paroi en aluminium satiné pour accrocher les porte-tablettes, porte-objets, porte-manteau, tableaux en stratifié et panneaux anti-bruit Snowsound.

D Kollektion von Accessoires für Tagungsräume, bestehend aus einem modularen Profil zur Wandmontage aus satiniertem Aluminium, an dem Tablet-Halter, Ablagen für Gegenstände, Kleiderhaken, Schreibtafeln und schallabsorbierende Snowsound Paneele angebracht werden können.

E Colección de accesorios para salas de reunión compuesta por un marco de pared expansible en aluminio satinado donde colgar porta tabletas, portaobjetos, portatrajes, pizarras de laminado y paneles fonoabsorbentes Snowsound.



**Sound
absorbing
panel**

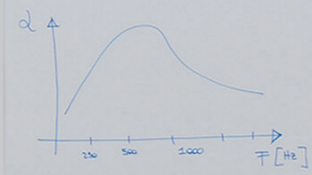

$$\frac{\partial^2 P(x,t)}{\partial x^2} = \frac{1}{c^2} \cdot \frac{\partial^2 P(x,t)}{\partial t^2}$$





SPEECH

Angelotti & Cardile

I Collezione di accessori ampia ed articolata, pensata per risolvere con un'unica linea coordinata le esigenze di ambienti polifunzionali, come sale riunioni e sale corsi. La collezione Speech prevede piani scrivibili in laminato, disponibili anche magnetici e completabili con pannello fonoassorbente, leggìo accessorabile in alluminio verniciato e portabiti stander. Tutti i prodotti sono caratterizzati dalla base in alluminio lucidato montata su ruote con freno e dalle strutture portanti in acciaio cromato.

EN A wide-ranging and rich assortment of coordinated accessories serving the needs of multifunctional environments, such as meeting rooms and lecture halls. The Speech collection includes writable laminate tops, also available as magnetic boards, sound-absorbing panels, accessorized lecterns in coated aluminum and mobile clothes stands. All the products are set on a base of polished cast aluminum mounted on lockable casters. The base supports a main structure made of chrome-plated steel.

F Une collection d'accessoires vaste et articulée, conçue pour résoudre avec une seule ligne coordonnée les besoins des lieux polyvalents, comme les salles de réunions et de cours. La collection Speech comprend des surfaces inscriptibles en stratifié, également en version magnétique à compléter par des panneaux phono-absorbant, pupitre de lecture avec accessoires en aluminium peint et portemanteaux. Tous les produits sont caractérisés par leur base en aluminium poli monté sur des roues avec frein et par les structures portantes en acier chromé.

D Eine breitgefächerte und artikulierte Kollektion an Zubehörelementen mit dem Ziel, durch eine einheitliche Produktlinie allen Anforderungen von Mehrzweckräumen wie Versammlungsräumen und Lehrräumen gerecht zu werden. Zur Speech-Kollektion gehören Schreibflächen aus Laminat (auf Wunsch magnetisch), die mit einer Schalldämpfplatte versehen werden können, ein mit Zubehör ausstattbarer Pult aus lackiertem Aluminium und Kleiderständer. Alle Produkte zeichnen sich durch den polierten Aluminiumfuss auf Rollen mit Bremse und durch ihr Chromstahlgestell aus.

E Colección amplia y diversificada de accesorios, concebida para solucionar con una línea única y coordinada las necesidades de los ambientes multifuncionales, como las salas de conferencias y las aulas de enseñanza. La colección Speech consta de superficies laminadas de escritura, también magnéticas, a las que se pueden añadir paneles fonoabsorbentes, un atril de aluminio pintado que se puede complementar y un perchero stander. Todos los productos se componen de una base de aluminio brillante montada sobre ruedas con freno y estructuras portantes de acero cromado.



67 x 60 x h 120 cm



123 x 60 x h 180 cm



123 x 60 x h 190 cm



73 x 60 x h 190 cm



73 x 60 x h 190 cm

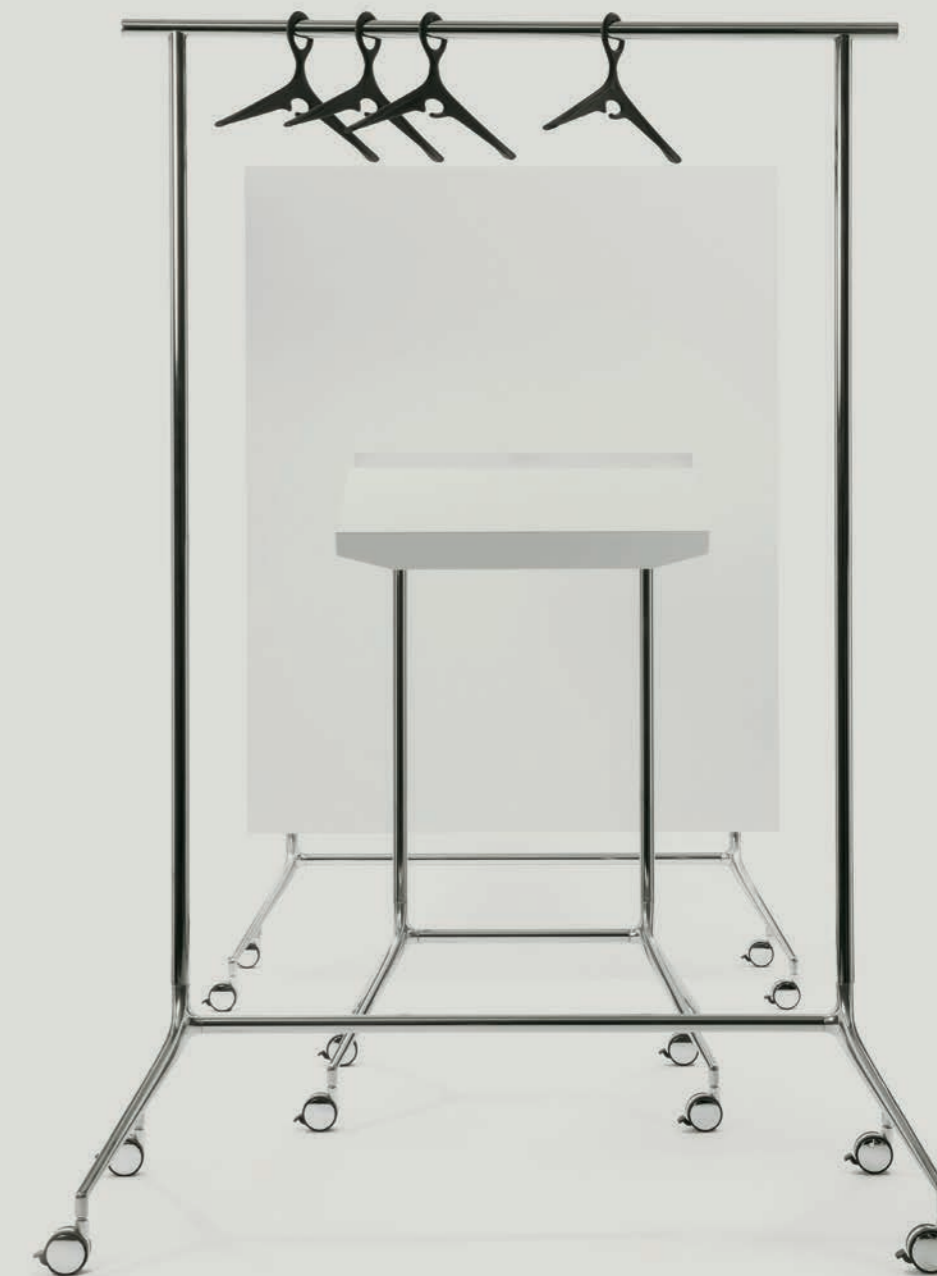



Speech lectern

I Il leggio è accessoriabile con vaschetta per l'alloggiamento dei cavi, completo di anelli passacavi in tecnopolimero applicabili alla struttura.

EN The Speech bookstand can be accessorized with a tray for organizing power cords, complete with high-tech polymer rings to fasten to the frame.

F Le podium peut être équipé d'un bac pour placer les câbles, équipé par des anneaux passe-câbles en technopolymère applicables à la structure.

D Das Rednerpult kann mit Kabelwanne und ringförmigen Kabelschläuchen aus Technopolymer ergänzt werden.

E El atril se puede complementar con una bandeja para el alojamiento de cables con anillos pasacables de tecnopolimero aplicables a la estructura.

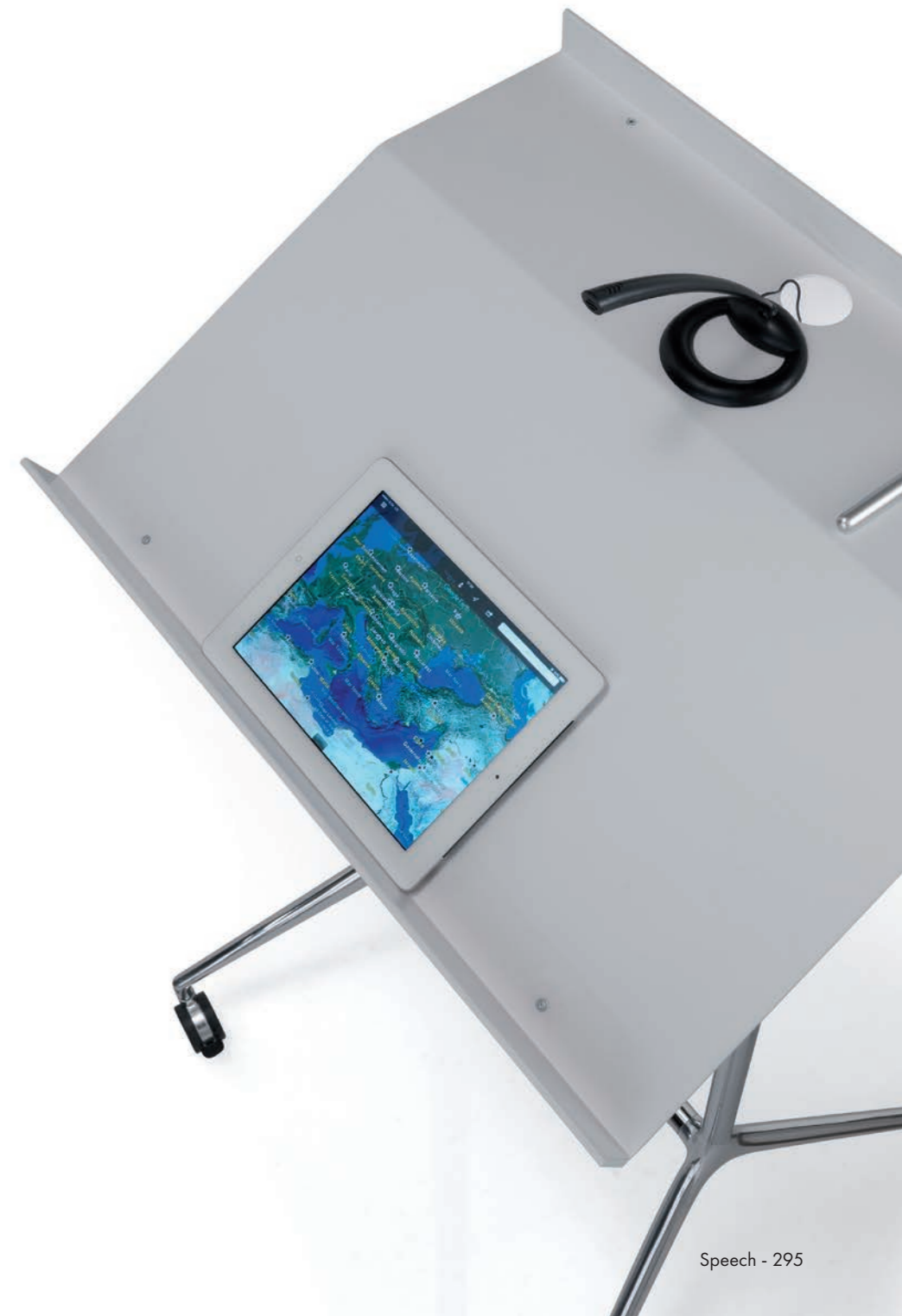

Speech write

I Piani scrivibili in laminato con struttura in acciaio cromato e caratterizzati dalla base in alluminio lucidato montata su ruote con freno. I piani scrivibili possono essere completati con un elemento fonoassorbente applicabile tramite Velcro alla parte posteriore del piano, realizzato in tessuto acustico Snowsound Fiber Textiles con imbottitura in fibre di poliestere. Il Tessuto è asportabile e lavabile.

EN Writable laminate tops supported by a chrome-plated steel structure set on a polished aluminum base mounted on lockable casters. The writable tops can be fitted with a sound-absorbing element attachable using a velcro strip at the back. The element is made from Snowsound Fiber Textiles with polyester fiber padding. Removable and washable fabric.

F Surfaces inscriptibles en stratifié avec structure en acier chromé et caractérisée par une base en aluminium poli montée sur des roues avec frein. Les surfaces inscriptibles peuvent être complétées par un élément phono-absorbant applicable avec du Velcro sur la partie postérieure de la surface, réalisé en tissu acoustique Snowsound Fiber Textiles avec rembourrage en fibres de polyester. Le tissu est amovible et lavable.

D Laminat-Schreibfläche mit Chromstahlgestell. Der polierte Aluminiumfuss ist auf Rollen montiert und mit Bremse versehen. Die Schreibflächen können durch eine mit Polyester gefüllte Schalldämpf-Platte aus Snowsound-Fiber-Textiles-Gewebe versehen werden, die durch Klettverschluss an der Rückseite befestigt wird. Abnehmbares und waschbares Gewebe.

E Superficies laminadas de escritura con estructura de acero cromado, que se componen de una base de aluminio brillante montada sobre ruedas con freno. Las superficies para escribir se pueden completar con un elemento fonoabsorbente de tejido acústico Snowsound Fiber Textiles acolchado con fibras de poliéster, que se adhiere mediante Velcro a la parte posterior de la superficie. El tejido es extraíble y lavable.

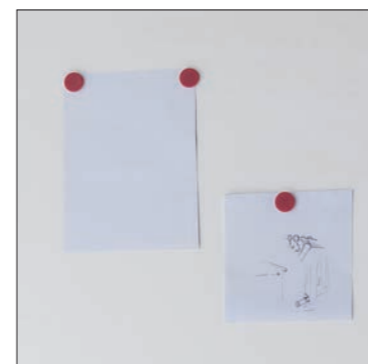
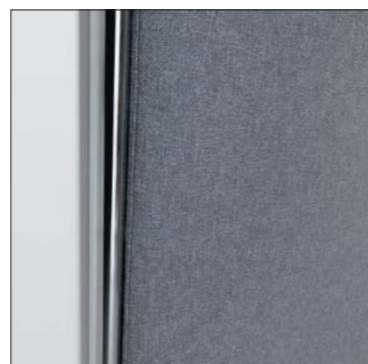

**Sound
absorbing
product**

KOALA

Michele De Lucchi con Sezgin Aksu

I_Sistema brevettato di segnaletica e comunicazione composto da una serie completa di espositori e portadepliant in acciaio verniciato con polveri epossidiche e PET trasparente, disponibili in diversi formati. I morsetti di aggancio sono in tecnopolimero.

EN _Patented sign and communication system formed by a complete line of displays and depliant holder in powder-coated steel and transparent PET, available in several sizes. Connecting clamps in high-tech polymer.

F_Système breveté de signalétique et communication composé d'une gamme complète de présentoirs et porte-dépliants en acier peint en époxy et PET transparent, disponibles en plusieurs formats. Pincés d'accrochage en technopolymère.

D_Patentiertes Schilder- und Kommunikationssystem. Eine komplette Linie von Schildern und Prospekthalter aus pulverbeschichtetem Stahl und transparentem PET, in vielen Grössen verfügbar. Befestigungen aus Technopolymer.

E_Sistema patentado de señalización y comunicación compuesto por una serie completa de expositores y portafolletos en acero recubierto con polvo epoxi y PET transparente, disponibles en diversos formatos. Terminales de conexión en tecnopolimero.





A5 O - A5 V
A4 O - A4 V
A3 O - A3 V
50x70 - 70x100

I_Gli espositori sono liberamente applicabili su due cavi di acciaio con diverse opzioni di aggancio a parete e a soffitto.

EN_Display units to freely mount on two steel cables with a variety of options for either wall or ceiling mounting.

F_Les présentoirs peuvent être librement appliqués sur deux câbles en acier avec différentes options de fixation à la paroi et au plafond.

D_Die Infotafeln können frei an zwei Stahlseilen mit verschiedenen Arten der Wand- oder Deckenbefestigung angebracht werden.

E_Los expositores se pueden aplicar en dos cables de acero con diferentes soluciones para sujetarlos a la pared o al techo.



A6 O
A5 O - A5 V
A4 O - A4 V

I_Espositori con fissaggio a parete in vetro mediante biadesivo.

EN_Display units to mount to the glass wall with double-sided adhesive.

F_Présentoirs à fixer à la paroi en verre avec une bande biadhésive.

D_Infotafeln zur Glaswandbefestigung mit Klebestreifen.

E_Expositores de vidrio con fijación de pared mediante cinta biadhesiva.



A6 O
A5 O - A5 V
A4 O - A4 V
A3 O - A3 V
50x70 - 70x100

I_Espositori con fissaggio diretto a parete con viti.

EN_Display units directly wall-mounted with screws.

F_Présentoirs avec fixage par vis directement sur la paroi.

D_Infotafeln mit direkter Wandbefestigung mit Schrauben.

E_Expositores con fijación en muro directa mediante tornillos.





I Utilizzando i cavi in acciaio dotati di ganci in metallo cromato, Koala si trasforma in un sistema per appendere quadri, stampe, immagini ecc. facilmente applicabile a parete o a soffitto.

EN The special steel cables equipped with chrome-plated hooks transform Koala into a system for suspending paintings, prints, pictures from the wall or from the ceiling.

F Avec des crochets en métal chromé appliqués aux câbles en acier, Koala devient un système d'accrochage pour tableaux, gravures, images etc., simple à appliquer au mur ou au plafond.

D Durch spezielle Stahlseile mit verchromten Haken wird Koala in ein System verwandelt, mit dem man Photos, Gemälde und Drucke von Wänden oder Decken abhängen kann.

E Los cables de acero equipados con ganchos cromados transforman Koala en un sistema para suspender los cuadros, dibujos y pinturas de la pared o del techo.

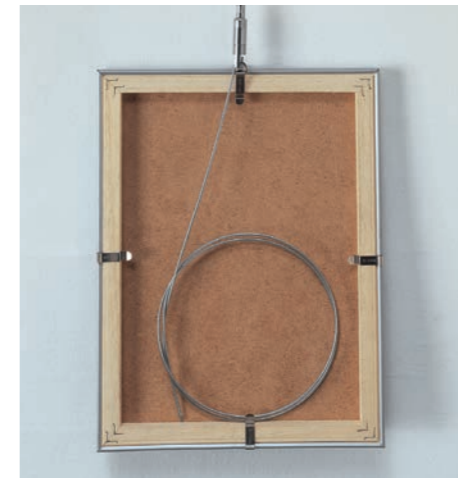

Istituto Europeo di Design, Madrid (Spain)

KOALA Totem

Michele De Lucchi con Sezgin Aksu

I_Totem espositori con struttura in acciaio verniciato, espositori in acciaio e PETG trasparente, portadepliant in acciaio.

EN_A display totem with an epoxy-coated steel tube upright supporting a display unit made from steel and transparent PET and/or supporting steel brochure/leaflet-holder.

F_Présentoirs totem avec une structure en acier peint, présentoirs en acier et PETG transparent, porte-dépliants en acier.

D_Auslageständer mit Chromstahlgestell, Auslagen aus Stahl und durchsichtigem PETG, Broschüren-Auslagen aus Stahl.

E_Tótems con estructura de acero pintado, expositores de acero y de PETG transparente, portafolletos de acero.

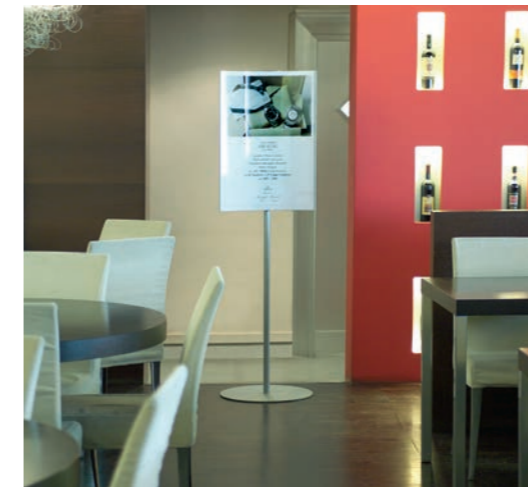

BATTISTA Stanchion

Michele De Lucchi con Sezgin Aksu

I_Colonnine Battista con cordone in tecnopolimero e ganci in metallo cromato. La colonnina è realizzata in acciaio verniciato con polveri epossidiche e base in ghisa verniciata con polveri epossidiche, dettagli in alluminio lucidato e acciaio inox.

EN_Battista columns with high-tech polymer cable and chrome-plated metal hooks. Column is in powder-coated steel with base in powder-coated cast iron, details in polished aluminum or stainless steel.

F_Colonnettes Battista avec cordon en technopolymère et crochets en métal chromé. La colonne est réalisée en acier peint en époxy et une base en fonte peinte en époxy, détails en aluminium poli et acier inox.

D_Battista Standsäulen mit Kordeln aus Technopolymer und verchromten Metallhaken. Die Säule ist aus pulverbeschichtetem Stahl mit Fuß bzw. Bodenplatte aus pulverbeschichtetem Gusseisen und Details aus poliertem Aluminium oder Edelstahl.

E_Columnitas Battista con cordón de tecnopolimero y sujeciones de metal cromado. La columna es de acero pintado con polvos epoxi y la base realizada en fundición gris, va recubierta con polvos epoxi, detalles de aluminio brillante y acero inox.



La Triennale di Milano (Italy)

BATTISTA Stanchion

Michele De Lucchi con Sezgin Aksu

I_Colonnina Battista con nastro estensibile ottenuta mediante una sofisticata lavorazione del tubolare d'acciaio che viene conificato per poter passare da un \varnothing 70 mm ad un \varnothing 32 mm. Questa tecnologia permette di realizzare una colonnina dalla forma sinuosa, esile nella parte inferiore per ridurre l'impatto visivo. La colonnina è realizzata in acciaio verniciato con polveri epossidiche e base in ghisa verniciata con polveri epossidiche, dettagli in alluminio lucidato e acciaio inox.

EN Battista small column with retractable tape obtained through a sophisticated working of the steel tubular, which is cone-shaped to change from a 70 mm dia to 32 mm dia. This technology allows to carry out a sinuous column; thin in the lower part for a lower visual impact. The column is made of epoxy powder coated steel and cast iron base painted with epoxy powders, details in polished aluminum and stainless steel.

F_Colonnette Battista avec ruban extensible obtenue au moyen d'un travail sophistiqué du tubulaire d'acier qui devient conique pour pouvoir changer de \varnothing 70 mm à \varnothing 32 mm. Cette technologie permet de réaliser une petite colonne à la forme sinueuse; mince dans la partie inférieure pour réduire l'impact visuel. La colonne est réalisée en acier peint en époxy et une base en fonte peinte en époxy, détails en aluminium poli et acier inox.

D_Der Battista kleine Säule mit ausziehbarem Band wird durch eine innovative Bearbeitung des Stahlrohrs erhalten. Der Battista Absperrpfosten mit Gurtkassette wird durch eine ausgefeilte Bearbeitung des Stahlrohrs in Kegelform geschaffen, wodurch der Durchmesser von 70 mm auf 32 mm verjüngt wird. Diese Technologie ermöglicht es, einen Absperrpfosten mit geschwungener Form zu erhalten, der im unteren Teil schlank ist, und dadurch eleganter wirkt. Die Standäule ist aus pulverbeschichtetem Stahl mit Fuß bzw. Bodenplatte aus pulverbeschichtetem Gusseisen und Details aus poliertem Aluminium oder Edelstahl.

E_Columna Battista con cinta extensible se obtiene mediante un sofisticado proceso del tubo de acero que se conifica para poder pasar de un \varnothing 70 mm a un \varnothing 32 mm. Esta tecnología permite realizar una columna de forma sinuosa, delgada en la parte inferior, para reducir el impacto visual. La columna es de acero pintado con polvos epoxi y base de hierro fundido pintado con polvos epoxi, detalles en aluminio pulido y acero inoxidable.



SET

Caimi Lab

ILa serie di colonnine serventi Set è caratterizzata dalla linea pulita ed essenziale, focalizzata sull'estrema funzionalità degli elementi e dei materiali che la compongono, è pensata per tutti quegli ambienti, pubblici e privati, in cui è necessario dividere, separare e organizzare lo spazio, i percorsi e la comunicazione, in modo efficace, ma con un impatto visivo leggero e poco invasivo. Le finiture in acciaio inox satinato, abbinata ai particolari in nero goffrato e la cura del dettaglio sono gli elementi di design che caratterizzano questa collezione.

ENThe defining characteristic of a stanchion from the Set series is its clean and austere linear configuration, which results from a design emphasis on the absolute functionality of its constituent elements and materials. Effective, yet also unobtrusive and visually inconspicuous, the stanchion is designed for public or private spaces that need to be divided, cordoned off or otherwise organized, as well as for access pathways and communication lines. The stanchions of this collection are notable for their satin stainless-steel finish, embossed black detailing, and meticulous design.

FLa série de colonnettes multi-fonction Set se distingue par sa ligne épurée et essentielle, concentrée sur la fonctionnalité extrême des éléments et des matériaux qui la composent. Elle a été conçue pour tous les espaces publics et privés où il faut diviser, séparer et organiser l'espace, les parcours et la communication de manière efficace, avec un impact visuel léger et discret. Les finitions inox satiné, associées aux éléments noirs gaufrés et une attention particulière aux détails sont les caractéristiques du design qui distinguent cette collection.

DDie Standsäulen der Serie Set zeichnen sich durch ihre klaren und essenziellen Linien aus. Das hohe Maß an Funktionalität der verwendeten Elemente und Materialien ist für alle öffentlichen und privaten Räumlichkeiten gedacht, in denen der Raum, der Durchgang und die Kommunikation geteilt, getrennt und organisiert werden müssen – wirksam, aber auf kaum sichtbare und unaufdringliche Art. Das Finish aus mattem Edelstahl, die schwarz geprägten Details und die Perfektion bei der Verarbeitung charakterisieren das Design dieser Kollektion.

ELa colección de postes delimitadores Set se caracteriza por su línea limpia y esencial, apuesta por la absoluta funcionalidad de los elementos y materiales que la conforman y está pensada para todos aquellos ambientes, tanto públicos como privados, en los que es necesario dividir, separar, organizar el espacio, el guiado peatonal y la comunicación de forma eficaz, pero con un impacto visual ligero y discreto. Los acabados en acero inoxidable satinado combinados con componentes en negro gofrado y la atención al detalle son los elementos de diseño distintivos de esta colección.



I_Set è costituita da una colonnina in acciaio inox satinato con base circolare, disponibile nelle finiture acciaio inox satinato o verniciata in colore nero gofrato. Sulla testa della colonnina si agganciano e si sganciano in modo semplice e rapido gli accessori tramite un innovativo sistema di innesto.

EN_Set stanchion consists of a satin stainless-steel pole standing on a circular base, likewise finished in satin stainless steel but also available with an embossed black coating. Accessories can be quickly and easily attached to and detached from the pole head thanks to an innovative coupling system.

F_Set est formé par un colonnette en acier finition inox satiné avec un pied circulaire, disponible en acier finitions inox satiné ou peint en noir gaufré. Sur la partie supérieure du colonnette les accessoires sont accrochés et décrochés rapidement et facilement grâce à un système d'ancrage innovant.

D_Set besteht aus einem matten Edelstahlständer mit kreisförmigem Bodenplatte, verfügbar in den Varianten Edelstahl matt oder lackiert in geprägtem Schwarz. Oben auf dem Standsäule werden die Accessoires dank eines innovativen Stecksystems schnell und einfach angebracht oder abgenommen.

E_Set está formada por un poste de acero inoxidable satinado con base circular, disponible con acabados en acero inoxidable satinado o recubierta en color negro gofrado. El cabezal del poste está dotado de un innovador sistema de fijación que permite enganchar y desenganchar los accesorios de forma sencilla y rápida.



I Elemento con 4 attacchi filettati per l'aggancio di corde elastiche. Realizzato in acciaio inossidabile satinato. Corda elastica con attacchi terminali a vite in acciaio e acciaio inossidabile.

EN Element with 4 threaded slots for the attachment elastic ropes. Made of satin stainless steel. Elastic ropes with screw-in end fitting made of steel and stainless steel.

F Élément avec 4 attaches filetées pour la fixation de cordes élastiques. Réalisé en acier inox satiné. Corde élastique avec attaches d'extrémité à vis en acier et en acier inox.

D Element mit 4 Vorrichtungen für das Einhaken von Expanderseilen. Aus mattem Edelstahl. Expanderseil mit schraubenförmigen Enden aus Stahl und Edelstahl.

E Elemento con 4 fijaciones de rosca para fijar cintas elásticas. Realizado en acero inoxidable satinado. Cinta elástica rematada con fijaciones de rosca en acero y acero inoxidable.

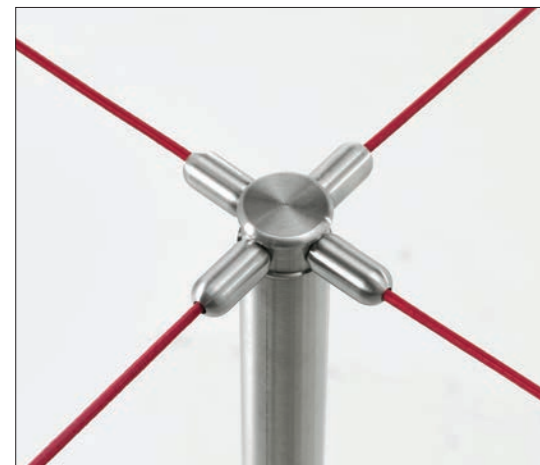

GASTONE

Caimi Lab

I Originale elemento divisorio con colonnine laterali in acciaio ricoperte e collegate da un unico cordone flessibile in tecnopolimero. Basi in acciaio inox massiccio. Gastone è facilmente trasportabile, elegante e adatto ad ogni tipo di ambiente.

EN An original room divider with steel side stanchions covered and connected by a single flexible high-tech polymer cord. Solid stainless steel bases. Gastone is elegant, easily transportable, and suits any type of environment.

F Élément de séparation original avec des colonnes latérales en acier recouvertes et liées à un seul cordon flexible en technopolymère. Bases en acier inoxydable massif. Gastone est facile à transporter, élégant et approprié à tout type d'intérieur.

D Originelles Trennelement mit seitlichen überzogenen Stahlständern, welche durch ein einziges flexibles Seil aus technischem Kunststoff verbunden werden. Die Ständer sind aus massivem Edelstahl. Gastone ist leicht zu transportieren, elegant und eignet sich für jeden Raum.

E Elemento separador original con montantes laterales de acero revestidos y conectados con un cordón flexible único de tecnopolímero. Bases de acero inoxidable macizo. Gastone se puede desplazar fácilmente, es elegante y adecuado a todo tipo de ambiente.

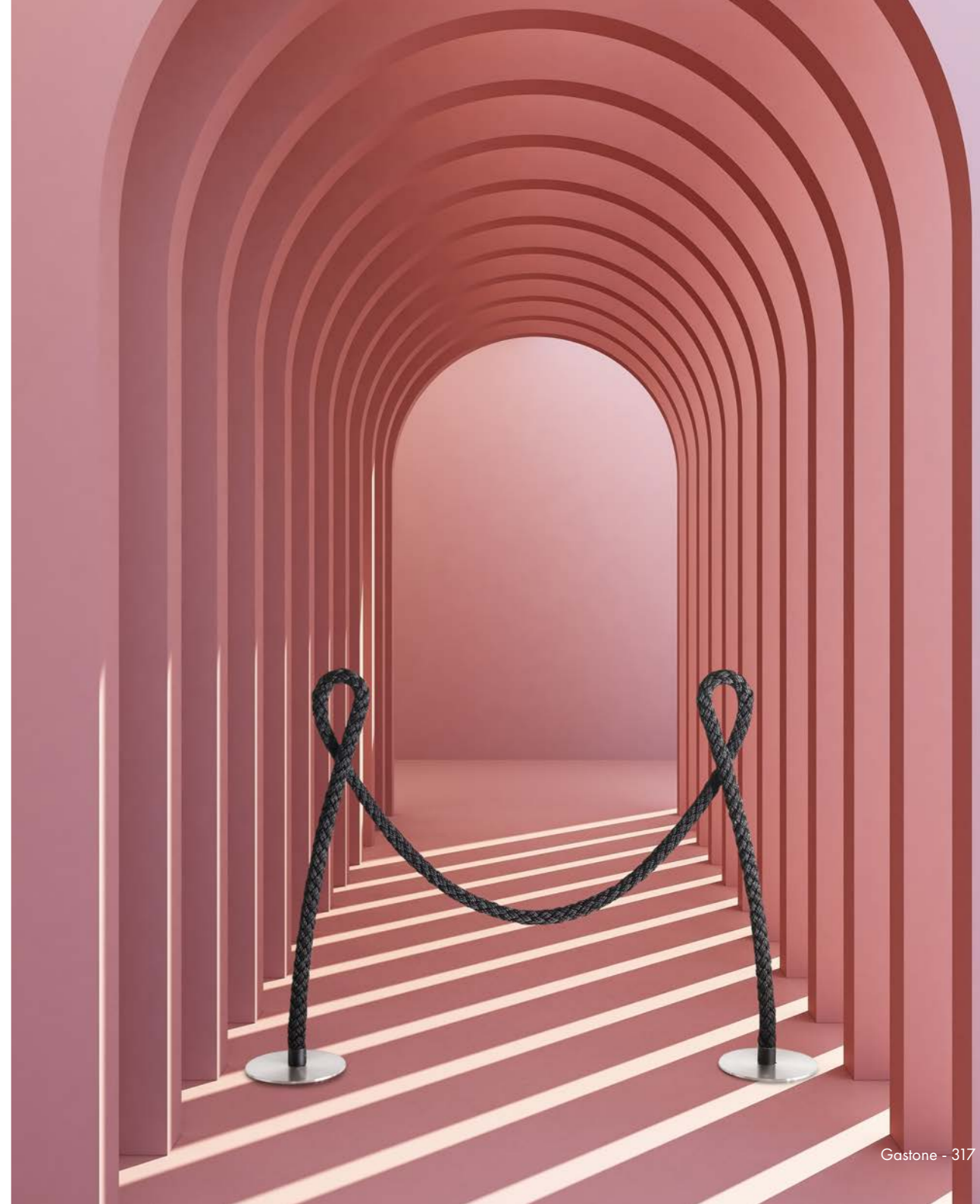

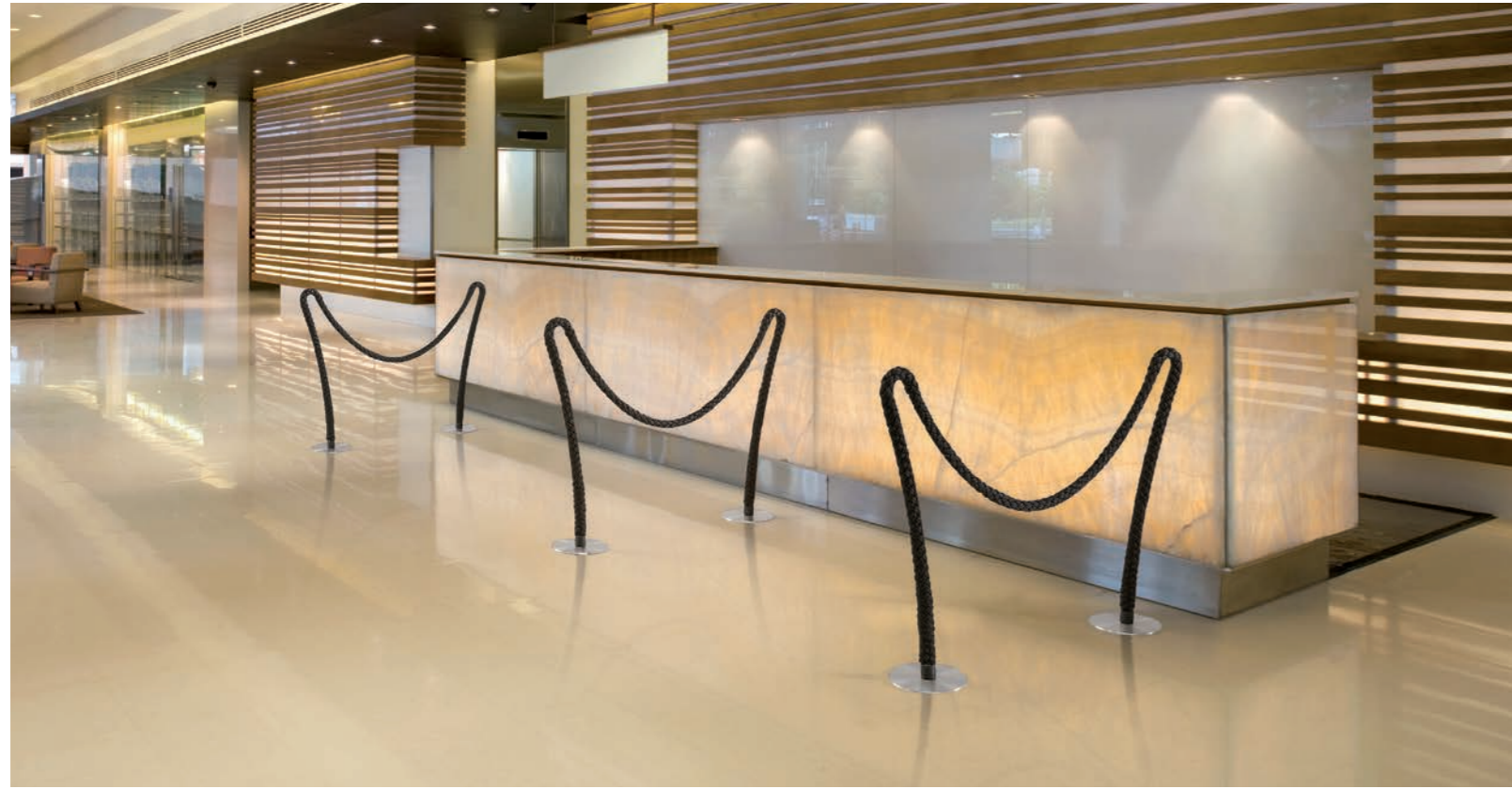

CAIMI BREVETTI S.p.A.

Via Brodolini, 25/27
20834 Nova Milanese - MB - Italy
Tel. 0362 49101
info@caimi.com
www.caimi.com

UFFICIO VENDITE ITALIA

Tel. 0362 491001
Fax 0362 491060
vendite.italia@caimi.com

EXPORT DEPARTMENT

Tel. (+39) 0362 491002
Fax (+39) 0362 491061
export.dept@caimi.com

I_Caimi Brevetti S.p.A. si riserva, a proprio insindacabile giudizio, la facoltà di modificare senza preavviso i materiali costruttivi, le caratteristiche tecniche ed estetiche, nonché le dimensioni degli elementi illustrati nel presente catalogo le cui immagini e colori sono puramente indicativi. Il testo facente fede è esclusivamente quello in lingua italiana, le traduzioni hanno la finalità esclusiva di semplificarne la lettura. Prima di procedere all'acquisto dei prodotti illustrati nel presente catalogo consultate le condizioni di vendita nonché le caratteristiche tecniche e le avvertenze riportate nel listino prezzi in vigore.

EN_Caimi Brevetti S.p.A. reserves, by its unappealable judgment, the right to modify without prior notice the building materials, the technical and aesthetic specifications, as well as the dimensions of the products in this catalogue, where pictures and colours are purely as an indication. The authentic text is only in Italian, the translation has the mere purpose of simplifying the reading. Prior to purchasing the products in this catalogue please consult the sale conditions and also the technical specifications and warnings in the current price list.

F_Caimi Brevetti S.p.A. se réserve, à son jugement sans appel, la faculté de modifier sans aucun préavis les matériaux de construction, les caractéristiques techniques et esthétiques ainsi que les dimensions des éléments illustrés dans ce catalogue, dont les images et couleurs sont seulement indicatifs. Le text de référence est seulement celui en italien, les traductions ont le seul but de simplifier la lecture. Avant de procéder à l'achat des produits illustrés dans ce catalogue, consulter les conditions de vente, les caractéristiques techniques et les mises en garde reportées dans le tarif en vigueur.

D_Caimi Brevetti S.p.A. behält sich das Recht vor, ihrer unanfechtbaren Entscheidung nach, verwendete Materialien, technische und ästhetische Details sowie die Abmessungen der in diesem Katalog abgebildeten Produkte ohne vorherige Ankündigung zu ändern. Die gezeigten Fotos und deren Farben dienen ausschliesslich zur ungefähren Information. Es ist ausschließlich der italienische Text verbindlich, die Übersetzungen dienen lediglich der vereinfachten Lesbarkeit. Es wird empfohlen, vor dem Erwerb der Artikel dieses Katalogs die Verkaufsbedingungen, die technischen Eigenschaften und Anweisungen in der gültigen Preisliste nachzusehen.

E_Caimi Brevetti S.p.A. se reserva, a su indiscutible juicio, el derecho a modificar sin previo aviso los materiales de construccion, las características tecnicas y esteticas, asi como las medidas de los productos del presente catalogo, donde las imagenes y los colores son meramente indicativos. El texto auténtico es exclusivamente lo en idioma italiano, las traducciones tienen el único propósito de simplificar la lectura. Antes de comprar los productos ilustrados en este catálogo, consulten las condiciones de venta, las características técnicas y las advertencias indicadas en la lista de precios en vigor.

STAMPA
Ingraph Srl

COPYRIGHT
Caimi Brevetti SpA 2024

ARCHIVIO FOTOGRAFICO
Caimi Brevetti SpA

FOTOGRAFIE & RENDER
Interno20
Raoul Iacometti
Nicolò Panzeri
Davide Limonta
Nube Architetture

close to people
close to the future